

TX-W36D3DP Service Manual

Safety

Specifications

Parts List

Service
Information

Adjustments

Self Check

Service Hints

Mechanical
View

Disassembly

Location of
Controls

Waveforms

Block Diagrams

Schematic Diagrams

PCB Views

Service Support

Service and repair of this product is supported by Panasonic's LUCI interface.

This interface provides a link between the TV and a standard PC to allow a number of diagnostic and control functions to be performed.

For more details contact your local Panasonic company.

BACK

EXIT

B2 - PCB

C - PCB

D2 - PCB

E - PCB

F - PCB

G - PCB

H - PCB

J - PCB

K - PCB

L - PCB

M3 - PCB

N - PCB

P - PCB

S - PCB

Y - PCB



BACK

Video / Audio

Control

Dolby



BACK

B2 - Schematic

C - Schematic

D2 - Schematic

E - Schematic

F - Schematic

G - Schematic

H - Schematic

J - Schematic

K - Schematic

L - Schematic

M3 - Schematic

N - Schematic

P - Schematic

S - Schematic

Y - Schematic



BACK

Service Manual



TELEVISORE A COLORI

TX-W36D3DP

TELAIO N. EURO-3HWS

Caratteristiche

Alimentazione :	220 - 240 V AC, 50Hz
Consumo :	239W
Impedenza dell' antenna :	75Ω unbalanced, Coaxial Type
Sistema di Ricezione:	PAL B/G, D/K, I, H, PAL - 60 SECAM B/G, D/K, L/L' M.NTSC, NTSC (Solo ingresso AV)
Canali Ricezione:	VHF E2 - E12 VHF H1 - H2 (ITALY) VHF A - H (ITALY) VHF R1 - R2 VHF R3 - R5 VHF R6 - R12 UHF E21 - E69 CATV (S01 - S05) CATV S1 - S10 (M1 - M10) CATV S11 - S20 (U1 - U10) CATV S21 - S41 (HYPERBAND)
Frequenze intermedie :	
Video	38.9MHz, 34MHz
Sound	32.9MHz, 33.4MHz 33.16MHz, 32.4MHz 40.4MHz, 34.05MHz, 33.05MHz 34.65MHz, 34.47MHz, 34.5MHz
Colore	
Video / Audio Prese :	
DOLBY SURROUND USCITA	Audio (RCA x 5) 500 mV rms 1kΩ
AV1 INGRESSO	Video (21 pin) 1 Vp-p 75Ω Audio (21 pin) 500 mV rms 10kΩ RGB (21 pin)
AV1 USCITA	Video (21 pin) 1 Vp-p 75Ω Audio (21 pin) 500 mV rms 1kΩ
AV2 INGRESSO	Video (21 pin) 1 Vp-p 75Ω Audio (21 pin) 500 mV rms 10kΩ S-Video IN Y: 1 Vp-p 75Ω (21 pin) C: 0.3 Vp-p 75Ω

AV2 USCITA	Video (21 pin) 1 Vp-p 75Ω Audio (21 pin) 500 mV rms 1kΩ Selectable output (21 pin)
AV3 INGRESSO	S-Video IN Y: 1 Vp-p 75Ω (4-pin) C: 0.3 Vp-p 75Ω Audio (RCA x 2) 500 mV rms 10kΩ Video (RCA x 1) 1 Vp-p 75Ω
AV4 INGRESSO	Video (21 pin) 1 Vp-p 75Ω Audio (21 pin) 500 mV rms 10kΩ
AV4 USCITA	Video (21 pin) 1 Vp-p 75Ω Audio (21 pin) 500 mV rms 1kΩ
Tensione all' anodo :	31 kV ±1kV
Tubo catodico :	W86KYP881X05 86 cm 106° deflection
Potenza audio :	
Altoparlanti interni	2 x 20W (Sinistro/Destro) (Musicali) 2 x 15W (Surround) (Musicali) 14W (Centre built-in) (Music) 20W (External Centrali) (Musicali)
Power)	8 Ω Impedance
Cuffia	8 Ω Impedance
Accessori :	Telecomando R6 (UM3) Batterie TS-500DP
Dimensioni :	Altezza : 618.5mm Larghezza : 894mm Profondità : 578.5mm
Peso netto	73.4kg

Le caratteristiche possono variare senza preavviso.
Peso e dimensioni sono approssimate

Panasonic

Indice

Norme Di Sicurezza	2
Ubicazione Del Controlli	3
Consigli Per L'assistenza	3
Valori di allineamento	4
Self Check	4
Schema a blocchi	5
Forma D' onda	8
Ubicazioni Del Componenti	9
Elenco Parti Di Ricambio	10
Vista Lato Componenti	26
Schema Elettrico	43

NORME DI SICUREZZA

Precauzioni

1. E' Consigliabile utilizzare un trasformatore di isolamento prima di eseguire ogni intervento sul telaio.
2. Durante l'assistenza, verificare lo stato dei conduttori specialmente nei circuiti ad alta tensione. In caso di corto circuito, sostituire tutti le parti surriscaldate o danneggiate.
3. Dopo l'assistenza, assicurarsi che tutti gli accorgimenti di protezione (isolatori, schermi, isolatore R-C, ecc) siano correttamente installati.
4. Quando il televisore non viene utilizzato per lunghi periodi, scollegarlo della rete.
5. Alta tensione (32kV) è presente quando il televisore è in funzione. Utilizzare il televisore senza il pannello posteriore comporta il pericolo di scosse elettriche dai circuiti di alimentazione. L'assistenza deve essere eseguita solo da personale specializzato a conoscenza delle necessarie precauzioni da adottare. Prima di intervenire sul cinescopio, scaricare a massa l'anodo dello stesso.
6. Dopo l'assistenza assicurarsi di eseguire le seguenti prove di dispersione per prevenire rischi di scossa elettrica all'utente.
3. Utilizzare un voltmetro AC con sensibilità 1000Ω/Volt o più per misurare il potenziale ai capi della resistenza.
4. Verificare ogni parte metallica esterna misurando la tensione ogni volta.
5. Invertire la presa AC di alimentazione e ripetere le misure precedenti.
6. Il potenziale in ogni punto non deve superare 1.4V RMS; in caso superi questo valore, c'è pericolo di scossa elettrica e il televisore deve essere riparato e controllata prima di essere riconsegnato al proprietario.

Esempio di collegamento per la dispersione a caldo

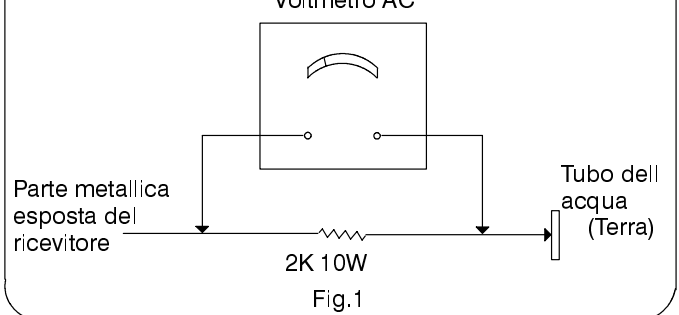

Controllo a freddo di dispersione

1. Disinserire il cavo di alimentazione e cortocircuitare i due terminali
2. Azionare l'interruttore di accensione.
3. Collegare uno strumento per la misure di resistenza con segur : un puntale sulla spina del cavo di alimentazione e l'altro sul telaio del televisore o su una parte metallica (ad esempio viti) collegate telaio. Se la parte metallica ha un collegamento col telaio la lettura dovrà essere compresa tra i valori 4MΩ e 20MΩ ; se la parte metallica non ha un collegamento con il telaio la lettura dovrà essere.

Controllo a caldo di dispersione

1. Inserire la spina nella presa di corrente. Non usare un trasformatore di isolamento per questo controllo.
2. Collagare una resistenza da 2KΩ 10W in serie con una parte metallica esterna del televisore e con un punto di terra (esempio: tubi dell'acqua).

Radiazioni raggi X

Precauzioni :

1. La sezione ad alta tensione e il cinescopio sono sorgenti di raggi X.
2. In caso di utilizzo di una sonda per alta tensione, assicurarsi che la stessa sopporti 32kV senza pericolo di emissione di raggi.

NOTA : E'importante verificare periodicamente la funzionalità del misuratore di tensione.

1. Regolare la luminosità al minimo.
2. Misurare l'alta tensione. La lettura dovrà essere 31kV ±1kV, (se è necessario un immediato intervento tecnico per prevenire danni).
3. Per prevenire la possibilità di emissione di raggi X, è indispensabile utilizzare il cinescopio specificato.

UBICAZIONE DEI CONTROLLI

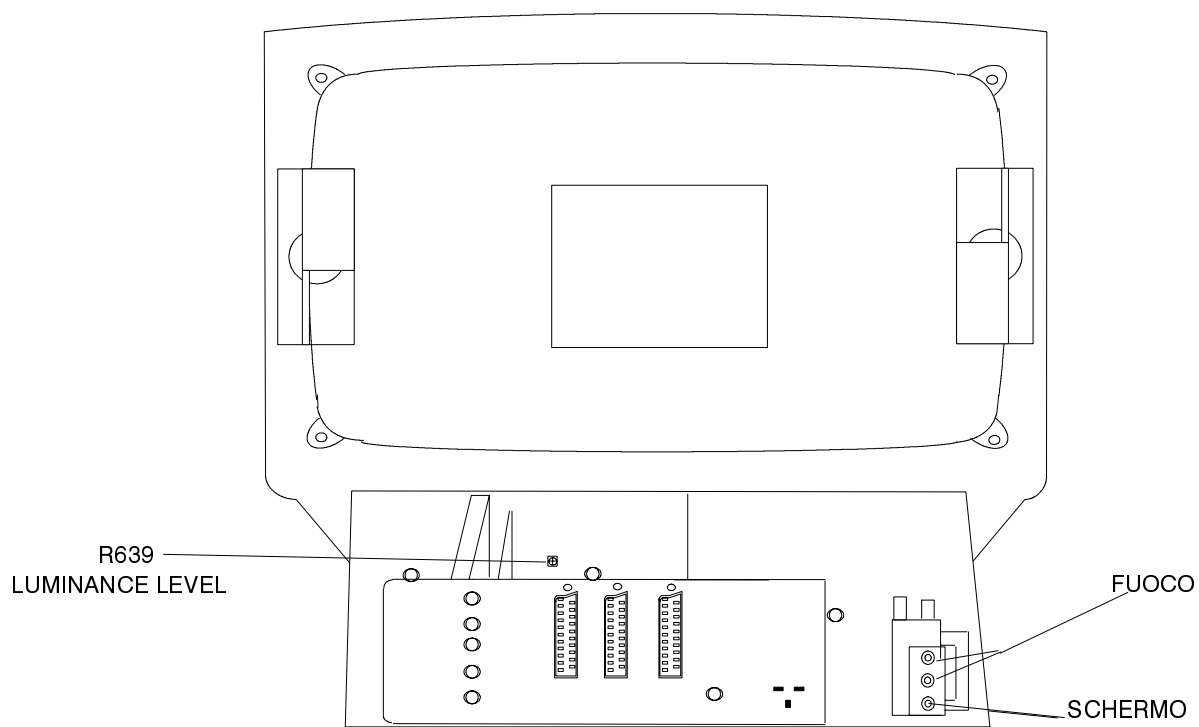

Fig.2

CONSIGLI PER L'ASSISTENZA

Come rimuovere il pannello posteriore

1. Rimuovere le 10 viti (A) come indicato in Fig.3/Fig.4

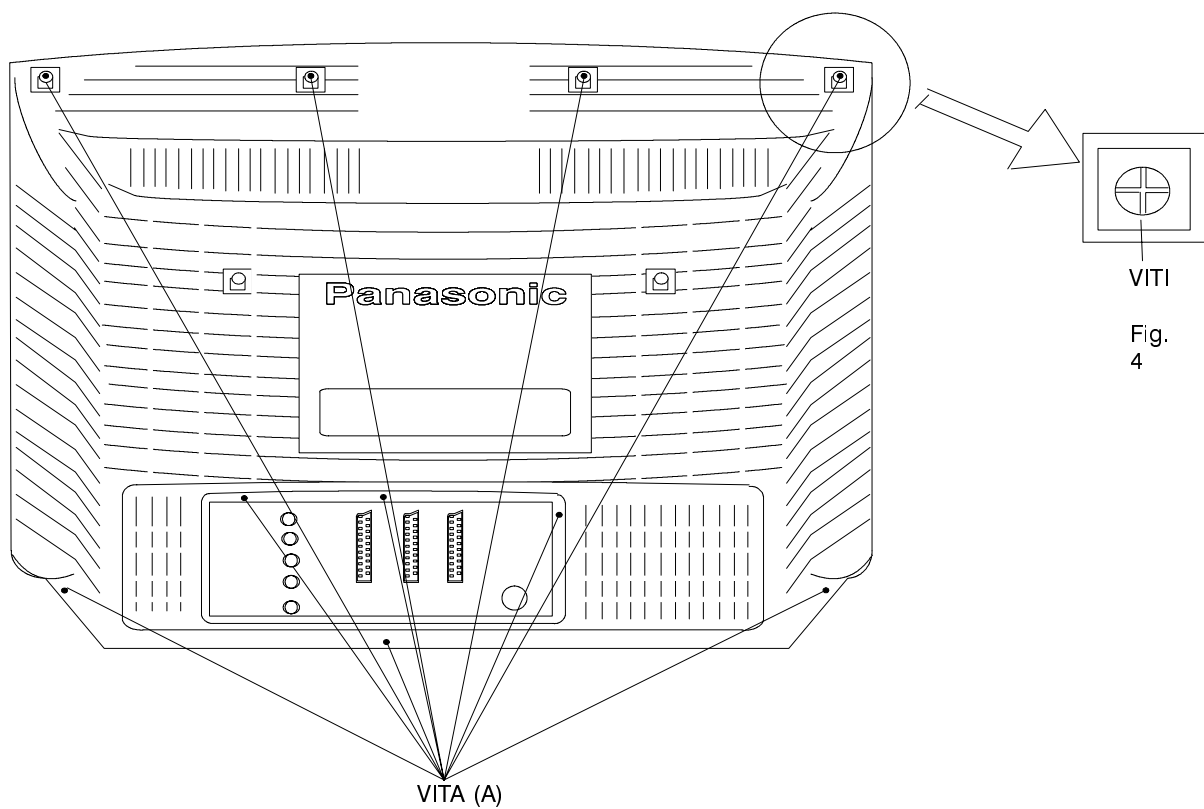

Fig.3.

Service Mode

Il telecomando serve anche per impostare e memorizzare le regolazioni con l'eccezione della regolazione di cut-off che deve essere sempre fatta precedentemente alle regolazioni di servizio.

Eeguire le regolazioni in accordo con il display sullo schermo. Il display sullo schermo mostra le variazioni approssimative della CCU.

1. Regolare i bassi al massimo, e gli Acuti al Minimo, premere il tasto REVEAL sul telecomando e contemporaneamente il tasto -/v posto nella tastiera del TV. (Con il TELECOMANDO SERVICE TZS2EK004 premere il tasto SERVICE e contemporaneamente il programma zero)
2. Premere i tasti ROSSO o VERDE per selezionare le Funzioni.
3. Premere i tasti GIALLO o BLU per modificare i valori
4. Premere il tasto "STR" sulla tastiera del TV per memorizzare la regolazione eseguita.
5. Per uscire dal service mode occorre premere il tasto " N " sul telecomando.

NOTA: Questo TV ha l'opzione per utilizzare la "MEMORY PACK", che vi permette di trasferire i canali sintonizzati nel TV e viceversa. La "MEMORY PACK" si puo' utilizzare solo con il telaio "EURO-3".

Come usare la Memory Pack

Procedura da TV a unita' di memoria

1. Inserire l'unita' di memoria nella presa a AV2 21 pin, ed accendere il TV.
2. Entrare nel service mode come da spiegazione sopra riportata. Lo schermo visualizzera': -

Program
External >> TV

3. Premere il tasto BLU sul telecomando; lo schermo TV visualizza: -

Program
TV >> External

4. Premere il tasto STORE (archivio) sul TV; lo schermo TV visualizza: -

Storing

5. Tutti i dati di sintonia archiviati nel TV vengono trasferiti nell'unita di memoria. Questa procedura richiede 2-3 minuti, ed al termine lo schermo visualizza: -

OK!

Procedura da unita' di memoria a TV

1. Inserire l'unita' di memoria nella presa a AV2 21 pin, ed accendere il TV.
2. Entrare nel service mode come da spiegazione sopra riportata. Lo schermo visualizzera': -

Program
External >> TV

3. Premere il tasto STORE (archivio) sul TV; lo schermo TV visualizza: -

Loading

4. Tutti i dati di sintonia archiviati nell'unita' di memoria vengono copiati nel 'TV'. Questa procedura richiede 2-3 minuti, ed al termine lo schermo visualizza: -

OK!

5. I dati di sintonizzazione prelevati dall'unita' di memoria sono stati copiati nel TV.
6. Per uscire dal service mode occorre premere il tasto " N " sul telecomando.
7. La procedura e' terminata; rimuovere l'unita' di memoria.

Errori

Se usando la "MEMORY PACK" avviene un errore il TV lo rilevera' e sullo schermo apparira' la scritta: -

Program
Error!

Se questo succede, spegnere il TV e poi ripetere l'operazione. Se si ripete l'errore controllare i collegamenti e la batteria da 9Volt. Nella "MEMORY PACK".

VALORI DI ALLINEAMENTO, ESEMPI:

N.B. I valori indicati sullo schermo sono approssimative.

Funzione di compensazione		Particolarità della posizionatura /Valori di pos.
Ampiezza vert	V-AMP 038	Posizione ottimale
Linearità vert	V-LIN 022	
Posizione verticale	V-POS 005	Posizione ottimale
Ampiezza orrizz	H-AMP 043	Posizione ottimale
posizione orrizz	H-POS 035	
EO-ampiezza	E/W-AMP 1 020	Posizione ottimale
EO-ampiezza	E/W-AMP 2 015	Posizione ottimale
Correz-trapezoidale	TRAPEZ-1 004	Posizione ottimale
Vert. DC.	VERT. D.C. 008	Non regolare
Text Position	TEXT POSITION 060	Posizione ottimale
Cutoff	- - -	Collegare la dei grigi, entrare nel SERVICE MODE fermandosi alla funzione CUT-OFF, porre la sonda dell'oscilloscopio sul catodo del BLU e regolare il potenziometro dello SCREEN nell'eat per ottenere 160V +/- 5V alla base dell' impulso del cut-off.
Cutoff RVB	CUTOFF RGB 032 032 032	Premere il tasto Verde per passare ad altre regolazioni. Regolare per la posizione ottimale.
White RVB	WHITE RGB 032 032 032	Premere il tasto Verde per passare ad altre regolazioni. Regolare per la posizione ottimale.
Sub Brightness	SUB BRIGHT 000	Posizione ottimale

PROCEDURA DI TARATURA

Item/Preparation	Adjustments
REGOLAZIONE +B	1. Confermare le seguenti alimentazioni.
1. Ricevere segnale a barre colori	E PCB
2. Predisporre i controlli:	D PCB
Luminosita' minimo	U5B 5 ± 0.5V
Contrasto minimo	U8B 8 ± 0.5V
Volume minimo	U8 8 ± 0.5V
	U9 9 ± 0.5V
	U12 11.8 ± 0.5V
	Pin3 IC2502 12 ± 0.5V
	Pin3 IC2503 5 ± 0.25V
	Pin3 IC2508 9 ± 0.3V
	No Load L2503 +20 ± 1V
	No Load L2503 -20 ± 1V
	U5A 5.1 ± 0.12/0.1V
	U5SB 5 ± 0.25V
	U15 15 ± 0.7V
	U16 16.1 ± 0.8V
	U22 22.5 ± 1V
	U38 38.5 ± 1V
	U47 47.5 ± 2.5V
	U150 150 ± 1V
	U200 206 ± 10V

SELF CHECK

Il "SELF CHECK" e' usato per testare le linee "BUS" tra la CPU e le altre sezioni del TV ad essa collegate. Se una di queste viene riconosciuta come "incorretta", due trattini meno (- -) verranno visualizzati al posto di "OK". Per accedervi premere sul telecomando il tasto di STATUS e contemporaneamente il tasto -/v nella tastiera del TV.:-

0 — ok	Tuner	8 — --	Dolby Sub	16 — ok	P SDA	Hexadecimalcode	
1 — ok	VIF	9 — --	Dolby IC for L/R	17 — ok	P SCL1		49
2 — ok	EEPROM	10 — --	Dolby IC for C/R	18 — ok	P SCL3		73
3 — ok	Sound AV switch1	11 — ok	P S MODE	19 — ok	P SCL4		FD
4 — ok	Video AV switch1	12 — ok	P TA0	20 — ok	P SBLED		1F
5 — ok	VDP	13 — ok	P TA1	21 — ok	P OFF		BB
6 — ok	TPU	14 — ok	P TA2	22 — ok	P DEFL		FB
7 — ok	MSP	15 — ok	P TA3	23 — ok	P RAM	43	

Se uno degli ingressi/uscite della "CCU" e' riconosciuta come incorretta, sullo schermo apparira' " - - " invece di "OK".

SCHEMA A BLOCCHI DOLBY

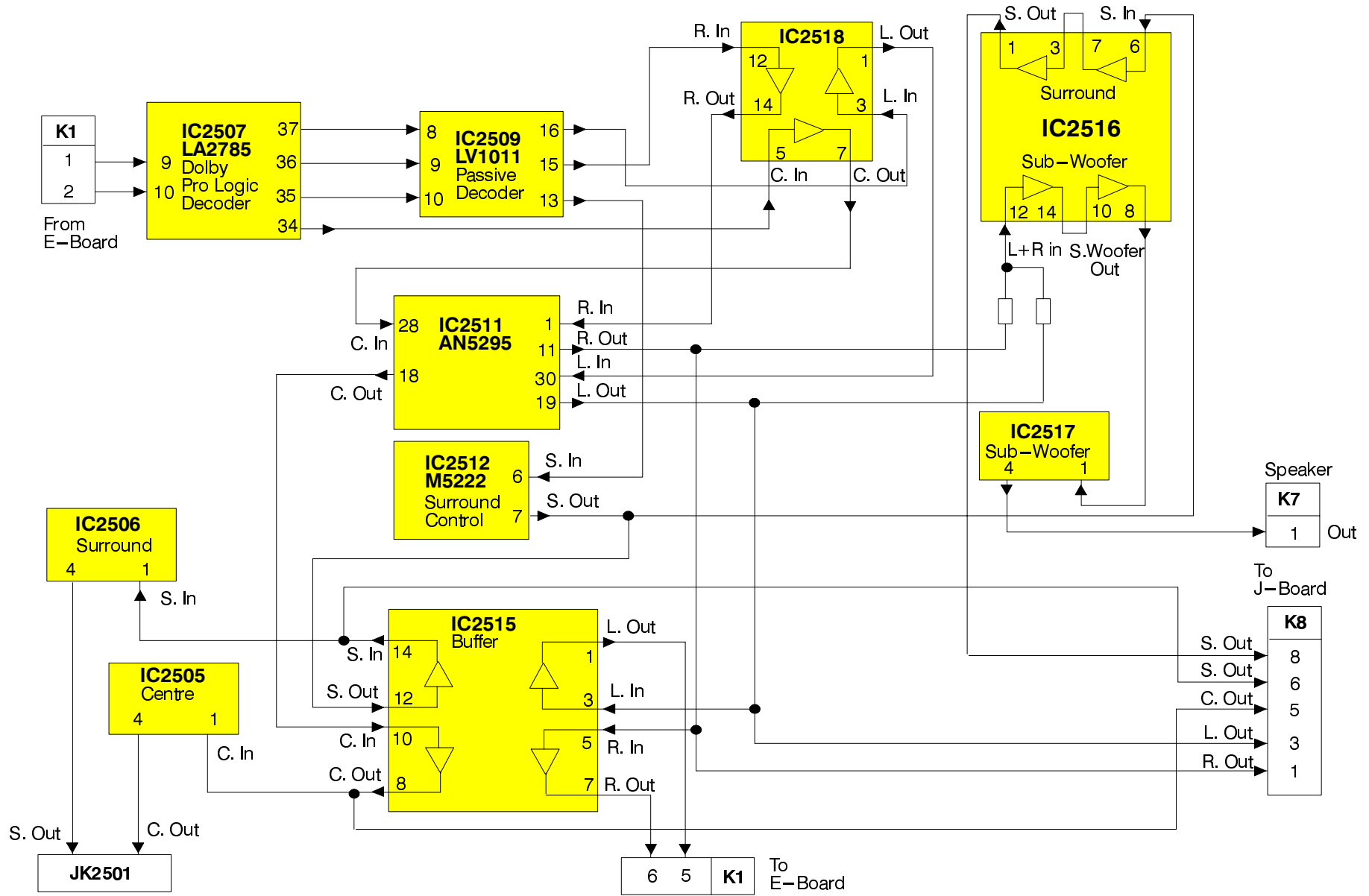

SCHEMA A BLOCCHI LINEE DI CONTROLLO

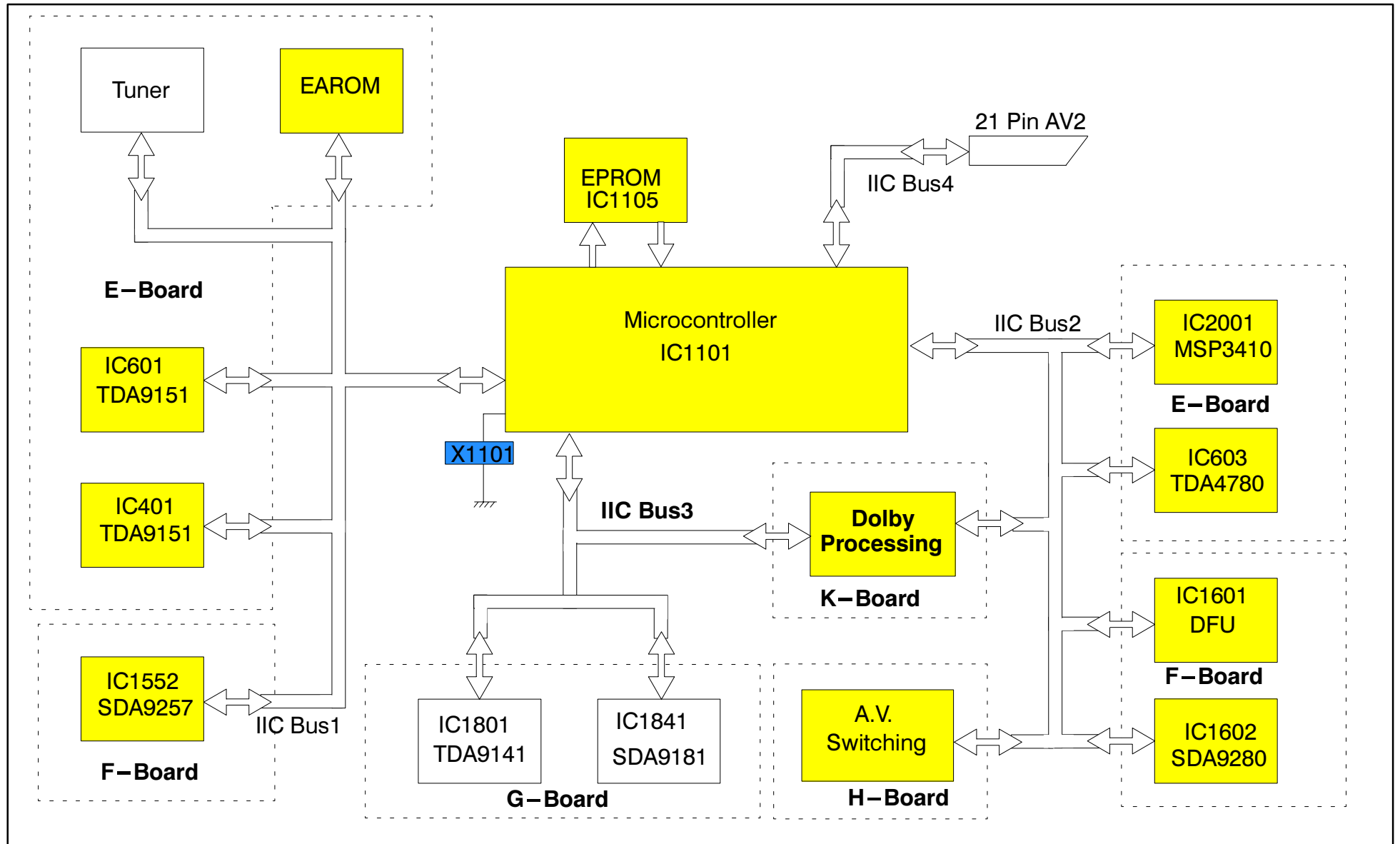

SCHEMA A BLOCCHI SIGNALI VIDEO / AUDIO

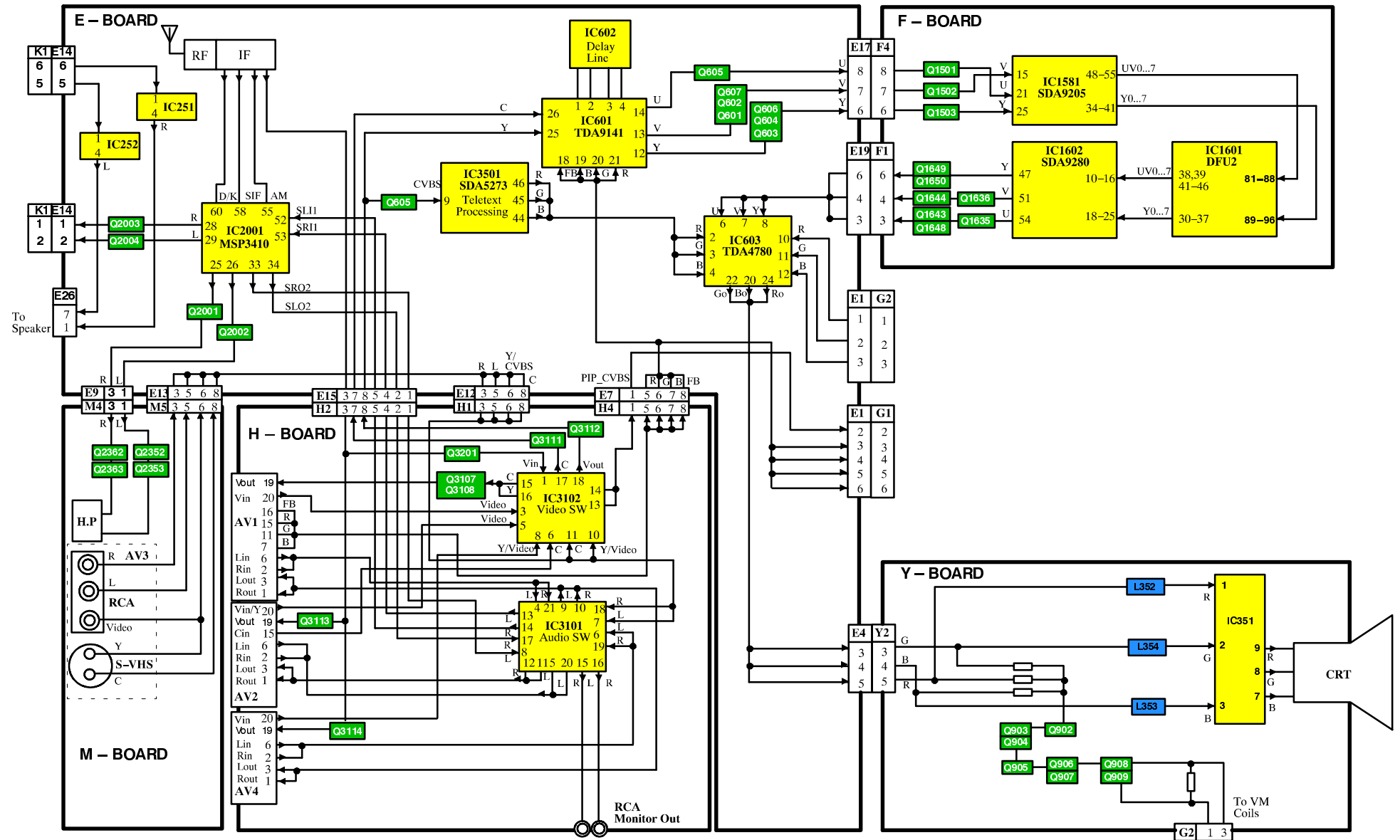

FORMA D'ONDA

NOTA: Tutte le forme d'onda sono state rese usando un segnale a barre colori standard.

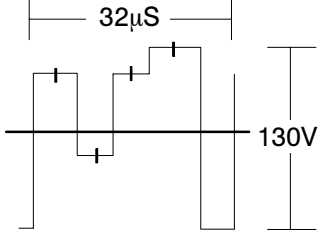
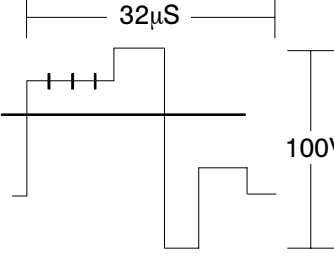
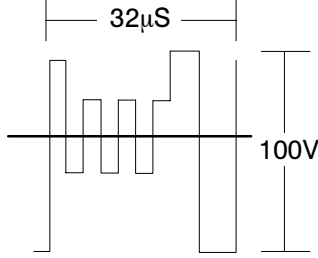
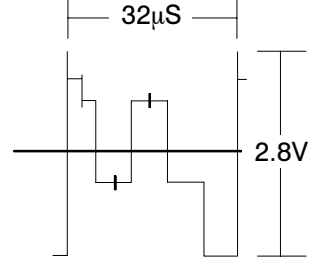
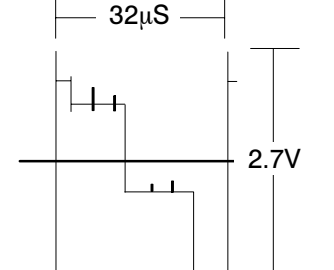
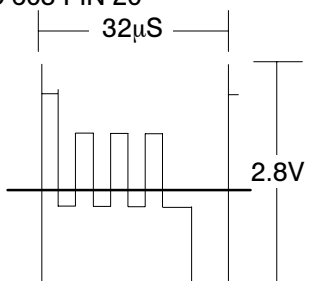
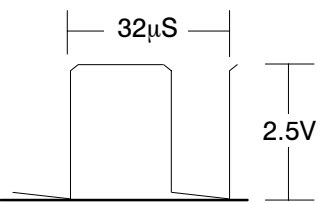
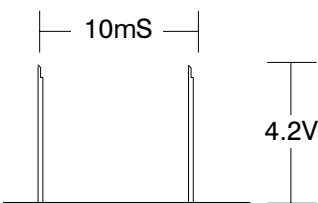
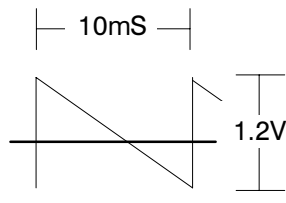
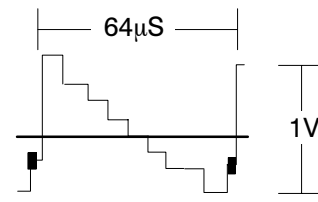
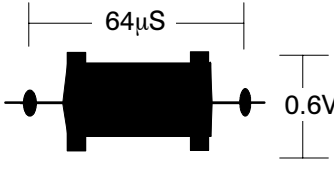
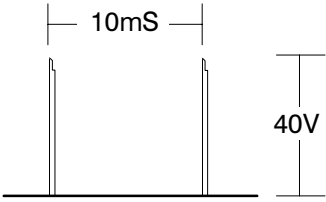
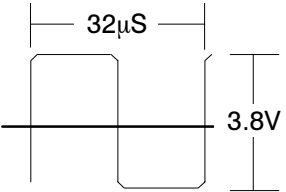
<p>RED DRIVE TPY1</p> 	<p>GREEN DRIVE TPY2</p> 	<p>BLUE DRIVE TPY3</p> 
<p>RED OUTPUT IC 603 PIN 24</p> 	<p>GREEN OUTPUT IC 603 PIN 22</p> 	<p>BLUE OUTPUT IC 603 PIN 20</p> 
<p>HORIZONTAL SYNC IC 3501 PIN 4</p> 	<p>VERTICAL SYNC IC 3501 PIN 3</p> 	<p>VERT OUTPUT IC (INPUT) IC 451 PIN 1</p> 
<p>LUMINANCE IN IC601 PIN 26</p> 	<p>CROMINANCE IN IC601 PIN 25</p> 	<p>VERTICAL OUTPUT (DRIVE) IC 451 PIN 9</p> 
<p>HORIZONTAL OUTPUT IC401 PIN 20</p> 		

UBICAZIONI DEI COMPONENTI

Nota :

In questa pagina i numeri all' interno di un cerchio corrispondono ai numeri riportanti nell' elenco parti di ricambio.

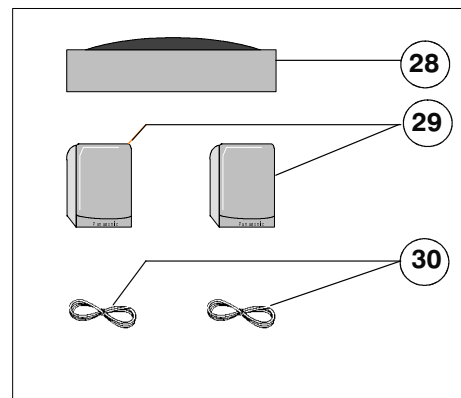
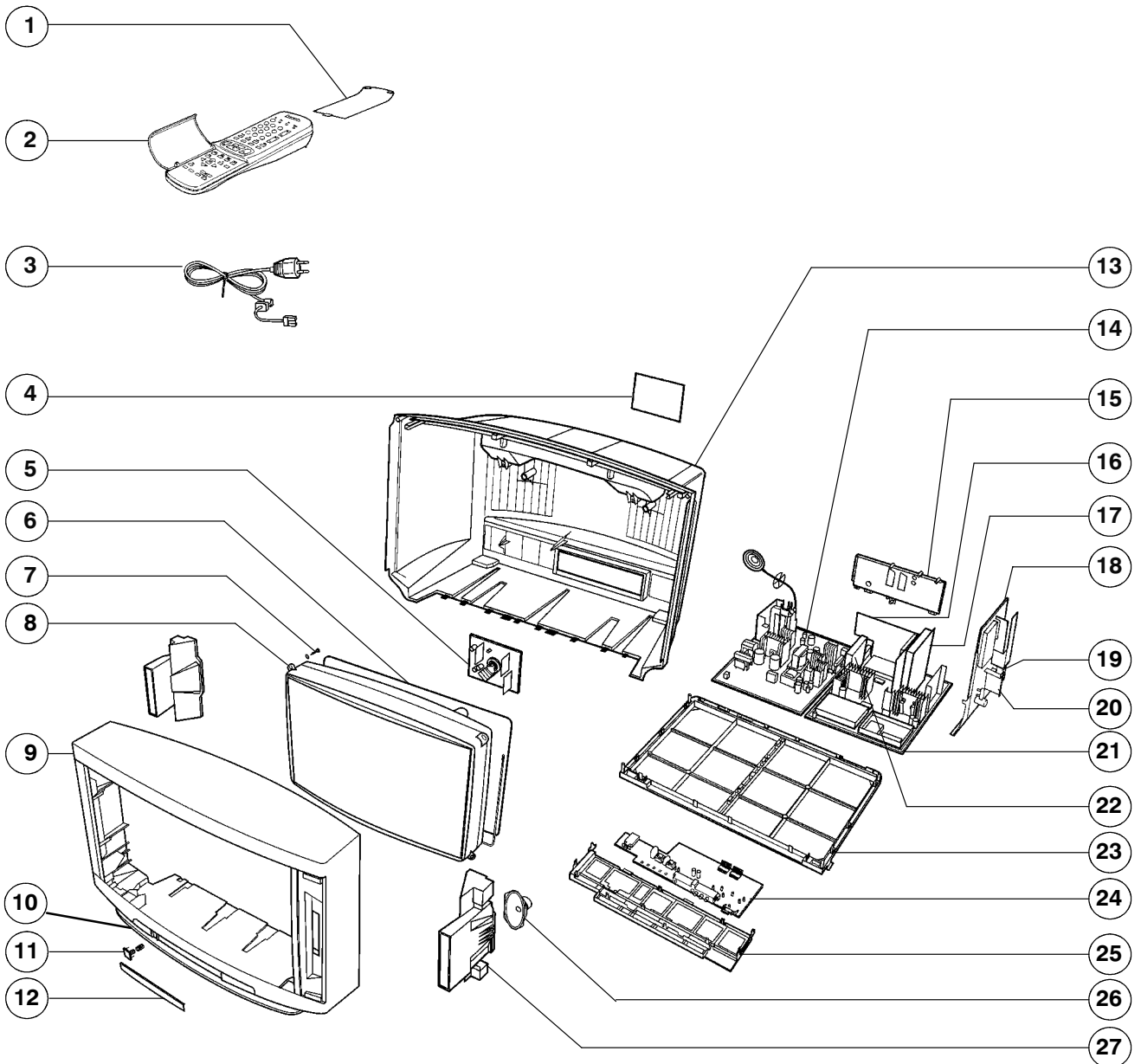

REPLACEMENT PARTS LIST

Important Safety Notice

Components identified by Δ mark have special characteristics important for safety. When replacing any of these components, use only manufacturer's specified parts.

Ref No.	Part No.	Description
MISCELLANEOUS COMPONENTS		
1)	UR51EC780	BATTERY COVER (REMOTE)
2)	EUR51924	REMOTE CONTROL
3)	TSX8E0011	MAINS LEAD Δ
4)	TBM8E1728	MODEL LABEL
5)	TNPA0292AE	Y P.C.B. Δ
6)	TXFLK01DCG	DEGAUSS COIL Δ
7)	THT1062	CRT FIXING SCREW
8)	W86KYP881X05	CRT
9)	TKYA02605	CABINET Δ
10)	TKPA05515	LEFT DOOR
11)	TBX8E047	POWER BUTTON
12)	TKPA05415	RIGHT DOOR
13)	TKUC01604	BACK COVER Δ
14)	TNPA0769	B P.C.B.
15)	TKP8E1227	AV PANEL
16)	TNPA0293AG	H P.C.B. Δ
17)	TNPA0294AC	F P.C.B. Δ
18)	TNPA0370AC	K P.C.B. Δ
19)	TNPA0458AA	J P.C.B. Δ
20)	TNP8EC002AC	C P.C.B. Δ
21)	TNPH0063AK	E P.C.B. Δ
22)	TNPA0317AB	B P.C.B. Δ
23)	TMX8E019	CHASSIS FRAME
24)	TNPA0762AA	M P.C.B. Δ
25)	TMX8E015	PCB SUPPORT BRACKET
26)	EAB12131RH	LOUDSPEAKER
28)	EASG12D123K2	CENTRE SPEAKER
29)	EAS8E002-A	REAR SPEAKERS
30)	TSX8E0015S	SPEAKER WIRE
	TNPA0297AB	G P.C.B. Δ
	TNPA0763AA	N P.C.B. Δ
	TNPA0764AA	P P.C.B. Δ
	TNPA0771AA	F P.C.B. Δ
	TNPA1042AA	L P.C.B. Δ
	EAB12131LH	LOUDSPEAKER
	EAS8E002-A	REAR SPEAKER COMPLETE
	PCS-068A-1	68 PIN I.C.SOCKET
	TBL63413	RUBBER
	TBM8E1777-1	REAR AV LABEL
	TBMC885	INDICATOR SHEET (R)
	TBMC886	INDICATOR SHEET (L)
	TMW8E023	CONTROL BRACKET
	TEK6940	LID CATCHER
	TES2298	CRT EARTH SPRING
	TKK8E028	AC CORD COVER
	TKPA05405	LID
	TKPA05612	INDICATOR PANEL
	TMW8E026	LED HOLDER
	TMWJ002	REMOTE CONTROL HOLDER
	TQB8E2481A	GERMAN INST BOOK Δ
	TQB8E2481B	DUTCH INST BOOK Δ
	TQB8E2481C	ITALIAN INST BOOK Δ
	TQB8E2481D	FRENCH INST BOOK1 Δ
	TQB8E2481E	SPANISH INST BOOK Δ
	TQB8E2481F	SWEDISH INST BOOK Δ
	TQB8E2481G	NORWEGIAN INST BOOK Δ
	TQB8E2481H	SUOMI INST BOOK Δ
	TQB8E2481K	DANISH INST BOOK Δ

Ref No.	Part No.	Description
	TQB8E2481U	ENGLISH INST BOOK Δ
	UM-3DJ-2P	BATTERY-SET
TNR1	ENV57D03G3	TUNER Δ
MOD16	TES4537	SPRING
MOD18	TES4537	SPRING
MOD20	TES4537	SPRING
MOD22	TES4537	SPRING
MOD25	31221212478	FIX CLIP
MOD6	TES4537	SPRING
MOE11	F9-4-220	RELAY
MOE12	TES4537	SPRING
MOS1	TES4537	SPRING
	TPC8E6419	TOP CARTON TOP
	TPC8E6420	OUTER CARTON
	TPD169487	HANDLE FOR CARTON
	TPD8E643	TOP CUSHION
	TPD8E644	PALLET LID
	TPD8E645	CUSHION-SET
	TPD8E646	RIGHT SPACER CUSHION
	TPD8E647	LEFT CUSHION SPACER
	ZTBZAA600A	ANODE LEAD
CAPACITORS		
C002	ECUV1H102JCX	S.M.CAP 50V 1nF
C003	ECA1HM101GB	LECT 50V 100 μ F
C004	ECUV1H102JCX	S.M.CAP 50V 1nF
C005	ECUV1H102JCX	S.M.CAP 50V 1nF
C006	ECUV1H102JCX	S.M.CAP 50V 1nF
C007	ECUV1H102JCX	S.M.CAP 50V 1nF
C009	ECA1HMR22GB	ELECT 50V 0.22 μ F
C010	ECUV1H102KBX	S.M.CAP 50V 1nF
C014	ECUV1H103ZFX	S.M.CAP 50V 10nF
C015	ECUV1H390JCX	S.M.CAP 50V 39pF
C016	ECUV1H390JCX	S.M.CAP 50V 39pF
C017	ECA1CM470GB	ELECT 16V 47 μ F
C019	ECUV1H561JCX	S.M.CAP 50V 560pF
C020	ECUV1H103ZFX	S.M.CAP 50V 10nF
C022	ECUV1H103ZFX	S.M.CAP 50V 10nF
C023	ECUV1H681JCX	S.M.CAP 50V 680pF
C024	ECUV1H103ZFX	S.M.CAP 50V 10nF
C025	ERJ6GEY0R00	S.M.CARB 0.1W 5% Ω
C026	ECUV1H681JCX	S.M.CAP 50V 680pF
C101	ECUV1H104ZFX	S.M.CAP 50V 100nF
C106	ECUV1H104ZFX	S.M.CAP 50V 100nF
C108	ECUV1H104ZFX	S.M.CAP 50V 100nF
C109	ECUV1H104ZFX	S.M.CAP 50V 100nF
C111	ECUV1H103ZFX	S.M.CAP 50V 10nF
C113	ECUV1H393KBX	S.M.CAP 50V 39nF
C115	ECUV1H104ZFX	S.M.CAP 50V 100nF
C116	ECUV1H030CPX	S.M.CAP 50V 30pF
C117	ECUV1H070DTX	S.M.CAP 50V 70pF
C118	ECEA1CKA100	ELECT 16V 10 μ F
C120	ECEA1HKA2R2	ELECT 50V 2.2 μ F
C121	ECEA1HKA2R2	ELECT 50V 2.2 μ F
C122	ECUV1C105ZFX	S.M.CAP 16V 1000nF
C123	ECEA1HKA2R2	ELECT 50V 2.2 μ F
C124	ECUV1H471JCX	S.M.CAP 50V 470pF
C125	ECUV1H104ZFX	S.M.CAP 50V 100nF
C126	ECUV1H104ZFX	S.M.CAP 50V 100nF
C127	ECEA1CKA100	ELECT 16V 10 μ F
C128	ECUV1H102KBX	S.M.CAP 50V 1nF
C129	ECEA1CKA100	ELECT 16V 10 μ F
C130	ECUV1H104ZFX	S.M.CAP 50V 100nF

Ref No.	Part No.	Description			
C131	ECUV1H102KBX	S.M.CAP	50V	1nF	
C132	ECUV1H102KBX	S.M.CAP	50V	1nF	
C133	ECUV1H102KBX	S.M.CAP	50V	1nF	
C134	ECUV1H104ZFX	S.M.CAP	50V	100nF	
C135	ECEA1CKA100	ELECT	16V	10µF	
C136	ECUV1H104ZFX	S.M.CAP	50V	100nF	
C137	ECUV1H100DCX	S.M.CAP	50V	10pF	
C138	ECUV1H151JCX	S.M.CAP	50V	150pF	
C139	ECUV1H104ZFX	S.M.CAP	50V	100nF	
C140	ECUV1H151JCX	S.M.CAP	50V	150pF	
C142	ECUV1H100DCX	S.M.CAP	50V	10pF	
C143	ECUV1H220JCX	S.M.CAP	50V	22pF	
C144	ECUV1H151JCX	S.M.CAP	50V	150pF	
C145	ECUV1H151JCX	S.M.CAP	50V	150pF	
C146	ECUV1H120JCX	S.M.CAP	50V	12pF	
C148	ECUV1H103ZFX	S.M.CAP	50V	10nF	
C150	ECEA1CKA100	ELECT	16V	10µF	
C151	ECUV1H104ZFX	S.M.CAP	50V	100nF	
C152	ECUV1H104ZFX	S.M.CAP	50V	100nF	
C153	ECUV1H120JCX	S.M.CAP	50V	12pF	
C158	ECUV1H103ZFX	S.M.CAP	50V	10nF	
C159	ECUV1H080CCX	S.M.CAP	50V	80pF	
C251	ECQM1H474J	FILM	50V	470nF	
C252	ECUV1H222JCX	S.M.CAP	50V	2.2nF	
C253	ECUV1C224KBX	S.M.CAP	16V	220nF	
C255	ECEA1CN100	ELECT	16V	10µF	
C256	ECA1HM100GB	ELECT	50v	10µF	
C257	ECA1HM100GB	ELECT	50v	10µF	
C258	ECQM1H474J	FILM	50V	470nF	
C259	ECUV1H222JCX	S.M.CAP	50V	2.2nF	
C260	ECUV1C224KBX	S.M.CAP	16V	220nF	
C262	ECEA1CN100	ELECT	16V	10µF	
C263	ECA1HM100GB	ELECT	50v	10µF	
C264	ECA1HM100GB	ELECT	50v	10µF	
C267	ECUV1H103ZFX	S.M.CAP	50V	10nF	
C268	ECUV1H223ZFX	S.M.CAP	50V	22nF	
C269	ECA1EM222GB	ELECT	25V	2.2nF	
C270	ECA1EM222GB	ELECT	25V	2.2nF	
C271	ECA1HM010GB	ELECT	50V	1µF	
C272	ECA1HM010GB	ELECT	50V	1µF	
C273	ECA1HM010GB	ELECT	50V	1µF	
C274	ECA1HM010GB	ELECT	50V	1µF	
C277	ECEA1HU471	ELECT	50V	470µF	
C281	ECUV1H104ZFX	S.M.CAP	50V	100nF	
C282	ECUV1H561JCX	S.M.CAP	50V	560pF	
C283	ECUV1H561JCX	S.M.CAP	50V	560pF	
C352	ECUV1H224ZFX	S.M.CAP	50V	0.22µF	
C353	ECUV1H103KBX	S.M.CAP	50V	10nF	
C354	ECKC2H103J	CERAMIC	50V	10nF	Δ
C355	ECKC2H102J	CERAMIC	500V	1nF	Δ
C362	ECUV1H224ZFX	S.M.CAP	50V	0.22µF	
C363	ECUV1H103KBX	S.M.CAP	50V	10nF	
C364	ECKC2H103J	CERAMIC	50V	10nF	Δ
C365	ECKC2H102J	CERAMIC	500V	1nF	Δ
C372	ECUV1H224ZFX	S.M.CAP	50V	0.22µF	
C373	ECUV1H103KBX	S.M.CAP	50V	10nF	
C374	ECKC2H103J	CERAMIC	50V	10nF	Δ
C375	ECKC2H102J	CERAMIC	500V	1nF	Δ
C381	ECA1HM101GB	ELECT	50V	100µF	
C382	ECA1CM471GB	ELECT	16V	470µF	
C383	ECUV1H103KBX	S.M.CAP	50V	10nF	
C384	ECQM2104KZ	FILM	250V	100nF	
C385	ECEA2EU220	ELECT	250V	22µF	
C386	ECKC3D392J	CERAMIC	2.0KV	3.9nF	
C395	ECQM1H104J	FILM	50V	100nF	
C402	ECUV1H104ZFX	S.M.CAP	50V	100nF	
C403	ECA1AM332E	ELECT	10V	3.3nF	
C404	ECUV1H104ZFX	S.M.CAP	50V	100nF	
C405	ECUV1H104ZFX	S.M.CAP	50V	100nF	
C406	ECUV1H471JCX	S.M.CAP	50V	470pF	
C413	ECUV1H561KBX	S.M.CAP	50V	560pF	
C451	ECUV1H104ZFX	S.M.CAP	50V	100nF	

Ref No.	Part No.	Description			
C452	ECA1EM332E	ELECT	25V	3.3nF	
C453	ECA1JM101B	ELECT	63V	100µF	
C455	ECEA1HN100	ELECT	50V	10µF	
C456	ECQV1104JZ3	FILM	100V	10µF	
C457	ECUV1H102JCX	S.M.CAP	50V	1nF	
C461	ECUV1C224KBX	S.M.CAP	16V	220nF	
C462	ECKC3A471J	CERAMIC	1KV	470pF	Δ
C463	ECUV1H102KBX	S.M.CAP	50V	1nF	
C464	ECKC1H102J	CERAMIC	50V	1000pF	
C501	ECQM1H224J	FILM	50V	220nF	
C502	ECQM2683JZ	FILM	250V	68nF	
C503	ECKC2H102J	CERAMIC	500V	1nF	Δ
C504	ECQM1H824J	FILM	50V	0.82µF	
C506	ECKC2H102J	CERAMIC	500V	1nF	Δ
C552	ECWH15H152J	FILM	100V	1.5nF	
C553	ECQM1273KZW	FILM	100V	27nF	
C554	ECQM4393JZW	FILM	400V	39nF	
C555	ECWH15H622J	FILM	100V	6.2nF	
C556	ECEA2CNR47SB	ELECT	160V	R47µF	
C557	ECKC2H331J	CERAMIC	500V	330pF	Δ
C558	ECA2EM330B	ELECT	250V	33µF	
C559	ECKC2H101J	CERAMIC	500V	100pF	Δ
C560	ECA1EM332E	ELECT	25V	3.3nµF	
C561	ECKC2H561J	CERAMIC	500V	560pF	Δ
C562	ECA1JM330B	ELECT	63V	33µF	
C563	ECWF2564JBK	FILM	200V	0.56µF	
C565	ECQM1273KZW	FILM	100V	27nF	
C566	ECKC2H222J	CERAMIC	500V	2200pF	Δ
C571	ECQV1H105JZ	FILM	50V	1µF	
C572	ECWH15H682J	FILM	100V	6.8nF	
C573	ECQF4153JZH	FILM	400V	15nF	
C574	ECWF2334JBB	FILM	200V	0.33µF	
C575	ECWF4684JBB	FILM	400V	0.68µF	
C576	ECWF2334JBB	FILM	200V	0.33µF	
C577	ECWF2105JBB	FILM	200V	1.0µF	
C578	ECKC1H101J	CERAMIC	50V	100pF	
C580	ECKC1H103JB	CERAMIC	50V	10nF	
C581	ECQF4153JZH	FILM	400V	15nF	
C584	ECKC3D331J	CERAMIC	2KV	330pF	Δ
C586	ECKC1H103JB	CERAMIC	50V	10nF	
C601	ECUV1H104ZFX	S.M.CAP	50V	100nF	
C602	ECUV1H104ZFX	S.M.CAP	50V	100nF	
C603	ECUV1H104ZFX	S.M.CAP	50V	100nF	
C604	ECUV1H104ZFX	S.M.CAP	50V	100nF	
C605	ECUV1H104ZFX	S.M.CAP	50V	100nF	
C606	ECUV1H104ZFX	S.M.CAP	50V	100nF	
C608	ECUV1H104ZFX	S.M.CAP	50V	100nF	
C609	ECUV1H180JCX	S.M.CAP	50V	18pF	
C610	ECUV1H150JCX	S.M.CAP	50V	15pF	
C611	ECUV1H104ZFX	S.M.CAP	50V	100nF	
C612	ECUV1H332ZFX	S.M.CAP	50V	3.3nF	
C613	ECUV1C474ZFX	S.M.CAP	16V	0.47µF	
C614	ECUV1H332ZFX	S.M.CAP	50V	3.3nF	
C615	ECUV1H104ZFX	S.M.CAP	50V	100nF	
C616	ECUV1H104ZFX	S.M.CAP	50V	100nF	
C617	ECA1CM220GB	ELECT	16V	22µF	
C618	ECUV1H104ZFX	S.M.CAP	50V	100nF	
C619	ECUV1H104ZFX	S.M.CAP	50V	100nF	
C620	ECUV1H104ZFX	S.M.CAP	50V	100nF	
C621	ECUV1H104ZFX	S.M.CAP	50V	100nF	
C622	ECUV1H104ZFX	S.M.CAP	50V	100nF	
C623	ECUV1H103ZFX	S.M.CAP	50V	10nF	
C624	ECUV1H103ZFX	S.M.CAP	50V	10nF	
C625	ECUV1H103ZFX	S.M.CAP	50V	10nF	
C626	ECUV1H103ZFX	S.M.CAP	50V	10nF	
C627	ECUV1H103ZFX	S.M.CAP	50V	10nF	
C628	ECUV1H103ZFX	S.M.CAP	50V	10nF	
C629	ECUV1H103ZFX	S.M.CAP	50V	10nF	
C630	ECUV1H103ZFX	S.M.CAP	50V	10nF	
C631	ECUV1H103ZFX	S.M.CAP	50V	10nF	
C632	ECUV1H103ZFX	S.M.CAP	50V	10nF	

Ref No.	Part No.	Description			
C633	ECUV1H470JCX	S.M.CAP	50V	47pF	
C634	ECA1CM221GB	ELECT	16V	220µF	
C635	ECA1HM220GB	ELECT	50V	22µF	
C636	ECA1HM010GB	ELECT	50V	1µF	
C637	ECQM1H224J	FILM	50V	220nF	
C638	ECA1HM010GB	ELECT	50V	1µF	
C639	ECQM1H224J	FILM	50V	220nF	
C640	ECQM1H224J	FILM	50V	220nF	
C641	ECQM1H224J	FILM	50V	220nF	
C642	ECA1AM470GB	ELECT	10V	47µF	
C643	ECUV1H104ZFX	S.M.CAP	50V	100nF	
C644	ECA1CM470GB	ELECT	16V	47µF	
C645	ECUV1H104ZFX	S.M.CAP	50V	100nF	
C646	ECUV1H104ZFX	S.M.CAP	50V	100nF	
C647	ECEA1CN470	ELECT	16V	47µF	
C648	ECEA1CN470	ELECT	16V	47µF	
C651	ECUV1H820JCX	S.M.CAP	50V	82pF	
C654	ECUV1H393KBX	S.M.CAP	50V	39nF	
C655	ECUV1E563KBX	S.M.CAP	25V	56nF	
C657	ECUV1C474ZFX	S.M.CAP	16V	0.47µF	
C659	ECUV1H821KBX	S.M.CAP	50V	820pF	
C661	ECUV1H103ZFX	S.M.CAP	50V	10nF	
C662	ECUV1H470JCX	S.M.CAP	50V	47pF	
C663	ECUV1H150JCX	S.M.CAP	50V	15pF	
C703	ECUV1C224KBX	S.M.CAP	16V	220nF	
C704	ECUV1H472KBX	S.M.CAP	50V	4.7nF	
C804	222233510154	CAPACITOR		0.15µF	
C806	ECQE6104K	FILM	600V	100nF	△
C807	ECQB1H104J	FILM	50V	100nF	
C808	ECQM1H334J	FILM	50V	330nF	
C811	ECQB1H104J	FILM	50V	100nF	
C812	ECQB1H562K	FILM	50V	5.6nF	
C813	ECKC2H472J	CERAMIC	500V	4.7nF	△
C814	ECKC2H472J	CERAMIC	500V	4.7nF	△
C815	ECA1CM331B	ELECT	16V	330µF	
C816	ECQB1H122J	FILM	50V	1.2nF	
C817	ECKC2H472J	CERAMIC	500V	4.7nF	△
C818	ECKC2H472J	CERAMIC	500V	4.7nF	△
C819	ECOS2WB221DB	ELECT	0V	220pF	
C820	ECOS2WB221DB	ELECT	0V	220pF	
C821	ECQB1H222J	FILM	50V	2200pF	
C822	ECKC3D471JB	CERAMIC	2KV	470pF	△
C824	ECQB1H181KF3	FILM	50V	0pF	
C826	ECQB1H473K	FILM	50V	47nF	
C827	ECKCNS332J	CERAMIC	1.2KV	3.3nF	△
C830	ECQE6105JFW	FILM	600V	1.0µF	
C831	ECKC3D471JB	CERAMIC	2KV	470pF	△
C833	ECQB1H682K	FILM	50V	6.8nF	
C835	ECQB1H332K	FILM	50V	3.3nF	
C836	222233510154	CAPACITOR		0.15µF	
C837	ECQE2A474MWB	FILM	100V	0.47µF	
C838	222233510154	CAPACITOR		0.15µF	
C848	ECKC2H471J	CERAMIC	500V	470pF	△
C849	ECKC2H471J	CERAMIC	500V	470pF	△
C852	ECKC3D152J	CERAMIC	2KV	1.5nF	△
C853	ECA1CM471GB	ELECT	16V	470µF	
C854	ECA1EM471GB	ELECT	25V	470µF	
C855	ECEA1HU102	ELECT	50V	1000µF	
C856	ECEA1HU471	ELECT	50V	470µF	
C857	ECA1EM471GB	ELECT	25V	470µF	
C858	ECOS2EA471CB	ELECT	250V	470pF	
C859	ECKC2H471J	CERAMIC	500V	470pF	△
C860	ECA1HM100GB	FELECT	50v	10µF	
C861	ECOS2EA221AB	ELECT	250V	220µF	
C863	ECA1EM332E	ELECT	25V	3.3nF	
C864	ECA0JM332E	ELECT	6.3V	3.3nF	
C866	ECA1HM101GB	ELECT	50V	100µF	
C867	ECA1CM222GB	ELECT	16V	2200µF	
C868	ECA1CM100GB	ELECT	16V	10µF	
C871	ECA0JM102GB	ELECT	6.3V	1nF	
C872	ECA1CM222GB	ELECT	16V	2200µF	
C873	ECA1CM100GB	ELECT	16V	10µF	

Ref No.	Part No.	Description			
C901	ECUV1H050CCX	S.M.CAP	50V	5pF	
C902	ECA1VM101GB	ELECT	35V	100µF	
C903	ECKC1H331J	CERAMIC	50V	330pF	
C904	ECUV1H103ZFX	S.M.CAP	50V	10nF	
C905	ECA1CM100GB	ELECT	16V	10µF	
C906	ECUV1H151JCX	S.M.CAP	50V	150pF	
C908	ECUV1H151JCX	S.M.CAP	50V	150pF	
C909	ECKC2H472J	CERAMIC	500V	4.7nF	△
C910	ECKC2H472J	CERAMIC	500V	4.7nF	△
C911	ECUV1H151JCX	S.M.CAP	50V	150pF	
C912	ECEA2EU220	ELECT	250V	22µF	
C913	ECA1HM101GB	ELECT	50V	100µF	
C914	ECA1HM101GB	ELECT	50V	100µF	
C915	ECA1CM471GB	ELECT	16V	470µF	
C916	ECEA2EU220	ELECT	250V	22µF	
C917	ECA1HM100GB	ELECT	50v	10µF	
C918	ECUV1H103ZFX	S.M.CAP	50V	10nF	
C1051	ECKC1H101J	CERAMIC	50V	100pF	
C1052	ECA1VM470B	ELECT	35V	47µF	
C1053	ECKC1H103JB	CERAMIC	50V	10nF	
C1102	ECUV1H104ZFX	S.M.CAP	50V	100nF	
C1103	ECUV1H104ZFX	S.M.CAP	50V	100nF	
C1104	ECA0JM101G	ELECT	6.3V	100µF	
C1105	ECUV1H330JCX	S.M.CAP	50V	33pF	
C1106	ECUV1H330JCX	S.M.CAP	50V	33pF	
C1107	ECUV1H391JCX	S.M.CAP	50V	390pF	
C1108	ECUV1H103ZFX	S.M.CAP	50V	10nF	
C1109	ECUV1H472KBX	S.M.CAP	50V	4.7nF	
C1110	ECUV1H104ZFX	S.M.CAP	50V	100nF	
C1111	ECUV1H101JCX	S.M.CAP	50V	100pF	
C1112	ECUV1H103ZFX	S.M.CAP	50V	10nF	
C1113	ECUV1H102JCX	S.M.CAP	50V	1nF	
C1114	ECUV1H102JCX	S.M.CAP	50V	1nF	
C1115	ECUV1H102JCX	S.M.CAP	50V	1nF	
C1126	ECUV1H104ZFX	S.M.CAP	50V	100nF	
C1127	ECUV1H104ZFX	S.M.CAP	50V	100nF	
C1129	ECA1AM470GB	ELECT	10V	47µF	
C1130	ECUV1H104ZFX	S.M.CAP	50V	100nF	
C1131	ECUV1H101JCX	S.M.CAP	50V	100pF	
C1133	ECUV1C184KBX	S.M.CAP	16V	0.18µF	
C1134	ECUV1H103KBX	S.M.CAP	50V	10nF	
C1135	ECUV1H103ZFX	S.M.CAP	50V	10nF	
C1136	ECUV1H101JCX	S.M.CAP	50V	100pF	
C1137	ECUV1H102KBX	S.M.CAP	50V	1nF	
C1138	ECUV1H104ZFX	S.M.CAP	50V	100nF	
C1302	ECUV1H150JCX	S.M.CAP	50V	15pF	
C1304	ECUV1H103ZFX	S.M.CAP	50V	10nF	
C1305	ECA1HM101GB	ELECT	50V	100µF	
C1306	ECUV1H104ZFX	S.M.CAP	50V	100nF	
C1307	ECUV1H104ZFX	S.M.CAP	50V	100nF	
C1308	ECA1HM101GB	ELECT	50V	100µF	
C1309	ECUV1H104ZFX	S.M.CAP	50V	100nF	
C1310	ECUV1H104ZFX	S.M.CAP	50V	100nF	
C1311	ECUV1H104ZFX	S.M.CAP	50V	100nF	
C1312	ECUV1H104ZFX	S.M.CAP	50V	100nF	
C1313	ECUV1H104ZFX	S.M.CAP	50V	100nF	
C1314	ECUV1H104ZFX	S.M.CAP	50V	100nF	
C1315	ECUV1H104ZFX	S.M.CAP	50V	100nF	
C1316	ECA1HM101GB	ELECT	50V	100µF	
C1317	ECUV1H104ZFX	S.M.CAP	50V	100nF	
C1318	ECA1HM101GB	ELECT	50V	100µF	
C1321	ECUV1H104ZFX	S.M.CAP	50V	100nF	
C1322	ECUV1H101JCX	S.M.CAP	50V	100pF	
C1323	ECA1HM101GB	ELECT	50V	100µF	
C1324	ECA1HM101GB	ELECT	50V	100µF	
C1325	ECUV1H103ZFX	S.M.CAP	50V	10nF	
C1326	ECUV1H104ZFX	S.M.CAP	50V	100nF	
C1327	ECUV1H104ZFX	S.M.CAP	50V	100nF	
C1508	ECUV1H103KBX	S.M.CAP	50V	10nF	
C1509	ECA1CM100GB	ELECT	16V	10µF	
C1518	ECA1HM101GB	ELECT	50V	100µF	
C1519	ECA1CM470GB	ELECT	16V	47µF	

Ref No.	Part No.	Description			
C1520	ECA1CM470GB	ELECT	16V	47µF	
C1521	ECUV1H390JCX	S.M.CAP	50V	39pF	
C1524	ECUV1H221JCX	S.M.CAP	50V	220pF	
C1525	ECUV1H391JCX	S.M.CAP	50V	390pF	
C1528	ECUV1H390JCX	S.M.CAP	50V	39pF	
C1529	ECUV1H221JCX	S.M.CAP	50V	220pF	
C1531	ECUV1H391JCX	S.M.CAP	50V	390pF	
C1532	ECUV1H151JCX	S.M.CAP	50V	150pF	
C1533	ECUV1H750JCX	S.M.CAP	50V	75pF	
C1534	ECUV1H391JCX	S.M.CAP	50V	390pF	
C1537	ECA0JM102GB	ELECT	6.3V	1nF	
C1552	ECUV1H104ZFX	S.M.CAP	50V	100nF	
C1554	ECUV1H104ZFX	S.M.CAP	50V	100nF	
C1555	ECA0JM331GB	ELECT	6.3V	330µF	
C1556	ECUV1H270JCX	S.M.CAP	50V	27pF	
C1557	ECUV1H270JCX	S.M.CAP	50V	27pF	
C1559	ECUV1H103KBX	S.M.CAP	50V	10nF	
C1560	ECUV1H103KBX	S.M.CAP	50V	10nF	
C1561	ECUV1H104ZFX	S.M.CAP	50V	100nF	
C1562	ECA0JM331GB	ELECT	6.3V	330µF	
C1564	ECUV1H104ZFX	S.M.CAP	50V	100nF	
C1575	ECUV1H104ZFX	S.M.CAP	50V	100nF	
C1576	ECUV1H104ZFX	S.M.CAP	50V	100nF	
C1577	ECA1CM470GB	ELECT	16V	47µF	
C1579	ECUV1H104ZFX	S.M.CAP	50V	100nF	
C1580	ECUV1H104ZFX	S.M.CAP	50V	100nF	
C1583	ECUV1H104ZFX	S.M.CAP	50V	100nF	
C1584	ECUV1H104ZFX	S.M.CAP	50V	100nF	
C1585	ECUV1H104ZFX	S.M.CAP	50V	100nF	
C1586	ECUV1H104ZFX	S.M.CAP	50V	100nF	
C1588	ECA1CM470GB	ELECT	16V	47µF	
C1590	ECUV1H104ZFX	S.M.CAP	50V	100nF	
C1591	ECUV1H104ZFX	S.M.CAP	50V	100nF	
C1592	ECUV1H104ZFX	S.M.CAP	50V	100nF	
C1593	ECA1CM470GB	ELECT	16V	47µF	
C1594	ECUV1H104ZFX	S.M.CAP	50V	100nF	
C1595	ECUV1H104ZFX	S.M.CAP	50V	100nF	
C1596	ECUV1H104ZFX	S.M.CAP	50V	100nF	
C1599	ECA1CM470GB	ELECT	16V	47µF	
C1601	ECUV1H104ZFX	S.M.CAP	50V	100nF	
C1602	ECUV1H104ZFX	S.M.CAP	50V	100nF	
C1603	ECUV1H103KBX	S.M.CAP	50V	10nF	
C1604	ECUV1H104ZFX	S.M.CAP	50V	100nF	
C1605	ECUV1H104ZFX	S.M.CAP	50V	100nF	
C1606	ECUV1H104ZFX	S.M.CAP	50V	100nF	
C1607	ECUV1H104ZFX	S.M.CAP	50V	100nF	
C1608	ECA1CM470GB	ELECT	16V	47µF	
C1610	ECUV1H104ZFX	S.M.CAP	50V	100nF	
C1611	ECUV1H103KBX	S.M.CAP	50V	10nF	
C1612	ECUV1H104ZFX	S.M.CAP	50V	100nF	
C1613	ECUV1H104ZFX	S.M.CAP	50V	100nF	
C1614	ECUV1H104ZFX	S.M.CAP	50V	100nF	
C1616	ECUV1H152JCX	S.M.CAP	50V	1.5pF	
C1617	ECUV1H104ZFX	S.M.CAP	50V	100nF	
C1618	ECUV1H104ZFX	S.M.CAP	50V	100nF	
C1619	ECUV1H104ZFX	S.M.CAP	50V	100nF	
C1620	ECUV1H104ZFX	S.M.CAP	50V	100nF	
C1621	ECA1CM470GB	ELECT	16V	47µF	
C1622	ECUV1H104ZFX	S.M.CAP	50V	100nF	
C1625	ECA1CM470GB	ELECT	16V	47µF	
C1641	ECA1CM470GB	ELECT	16V	47µF	
C1642	ECUV1H104ZFX	S.M.CAP	50V	100nF	
C1701	ECA1CM470GB	ELECT	16V	47µF	
C1702	ECUV1H104ZFX	S.M.CAP	50V	100nF	
C1703	ECUV1H104ZFX	S.M.CAP	50V	100nF	
C1704	ECUV1H104ZFX	S.M.CAP	50V	100nF	
C1705	ECUV1H104ZFX	S.M.CAP	50V	100nF	
C1706	ECUV1H104ZFX	S.M.CAP	50V	100nF	
C1707	ECUV1H104ZFX	S.M.CAP	50V	100nF	
C1708	ECUV1H104ZFX	S.M.CAP	50V	100nF	
C1709	ECUV1H104ZFX	S.M.CAP	50V	100nF	
C1710	ECUV1H104ZFX	S.M.CAP	50V	100nF	

Ref No.	Part No.	Description			
C1711	ECUV1H103KBX	S.M.CAP	50V	10nF	
C1712	ECUV1H104ZFX	S.M.CAP	50V	100nF	
C1713	ECUV1H104ZFX	S.M.CAP	50V	100nF	
C1714	ECUV1H104ZFX	S.M.CAP	50V	100nF	
C1721	ECA1CM470GB	ELECT	16V	47µF	
C1722	ECA1CM470GB	ELECT	16V	47µF	
C1723	ECUV1H104ZFX	S.M.CAP	50V	100nF	
C1724	ECUV1H104ZFX	S.M.CAP	50V	100nF	
C1725	ECUV1H104ZFX	S.M.CAP	50V	100nF	
C1726	ECUV1H104ZFX	S.M.CAP	50V	100nF	
C1727	ECUV1H104ZFX	S.M.CAP	50V	100nF	
C1728	ECUV1H104ZFX	S.M.CAP	50V	100nF	
C1729	ECUV1H104ZFX	S.M.CAP	50V	100nF	
C1730	ECUV1H104ZFX	S.M.CAP	50V	100nF	
C1731	ECUV1H104ZFX	S.M.CAP	50V	100nF	
C1732	ECUV1H104ZFX	S.M.CAP	50V	100nF	
C1733	ECUV1H104ZFX	S.M.CAP	50V	100nF	
C1734	ECUV1H104ZFX	S.M.CAP	50V	100nF	
C1735	ECUV1H104ZFX	S.M.CAP	50V	100nF	
C1736	ECUV1H104ZFX	S.M.CAP	50V	100nF	
C1740	ECUV1H102KBX	S.M.CAP	50V	1nF	
C1801	ECUV1C104KBX	S.M.CAP	16V	0.10µF	
C1802	ECUV1C104KBX	S.M.CAP	16V	0.10µF	
C1803	ECUV1C104KBX	S.M.CAP	16V	0.10µF	
C1804	ECUV1C104KBX	S.M.CAP	16V	0.10µF	
C1805	ECUV1H104ZFX	S.M.CAP	50V	100nF	
C1806	ECUV1C104KBX	S.M.CAP	16V	0.10µF	
C1807	ECUV1C104KBX	S.M.CAP	16V	0.10µF	
C1808	ECUV1C104KBX	S.M.CAP	16V	0.10µF	
C1809	ECUV1C104KBX	S.M.CAP	16V	0.10µF	
C1810	ECUV1H103ZFX	S.M.CAP	50V	10nF	
C1811	ECUV1C104KBX	S.M.CAP	16V	0.10µF	
C1812	ECUV1H104ZFX	S.M.CAP	50V	100nF	
C1813	ECUV1H332KBX	S.M.CAP	50V	3.3nF	
C1814	ECUV1C104KBX	S.M.CAP	16V	0.10µF	
C1815	ECUV1H180JCX	S.M.CAP	50V	18pF	
C1816	ECUV1H150JCX	S.M.CAP	50V	15pF	
C1817	ECUV1H104ZFX	S.M.CAP	50V	100nF	
C1818	ECUV1H331JCX	S.M.CAP	50V	330pF	
C1819	ECUV1H331JCX	S.M.CAP	50V	330pF	
C1820	ECUV1H680JCX	S.M.CAP	50V	68pF	
C1821	ECUV1H103KBX	S.M.CAP	50V	10nF	
C1822	ECUV1H103KBX	S.M.CAP	50V	10nF	
C1823	ECUV1H104ZFX	S.M.CAP	50V	100nF	
C1824	ECA1AM470GB	ELECT	10V	47pF	
C1825	ECQB1H563K	FILM	50V	56nF	
C1826	ECUV1H152KBX	S.M.CAP	50V	1.5pF	
C1827	ECUV1H104ZFX	S.M.CAP	50V	100nF	
C1828	ECA1HM010GB	ELECT	50V	1µF	
C1829	ECUV1C104KBX	S.M.CAP	16V	0.10µF	
C1840	ECUV1C104KBX	S.M.CAP	16V	0.10µF	
C1843	ECUV1H104ZFX	S.M.CAP	50V	100nF	
C1845	ECA1AM470GB	ELECT	10V	47µF	
C1846	ECUV1H104ZFX	S.M.CAP	50V	100nF	
C1861	ECUV1H561KBX	S.M.CAP	50V	560pF	
C1862	ECUV1H561KBX	S.M.CAP	50V	560pF	
C1865	ECA1AM470GB	ELECT	10V	47µF	
C1881	ECUV1H104ZFX	S.M.CAP	50V	100nF	
C1882	ECA1AM470GB	ELECT	10V	47µF	
C1887	ECA1HM101GB	ELECT	50V	100µF	
C1888	ECUV1H104ZFX	S.M.CAP	50V	100nF	
C1891	ECUV1H332KBX	S.M.CAP	50V	3.3nF	
C1892	ECUV1C104KBX	S.M.CAP	16V	0.10µF	
C1894	ECA1AM470GB	ELECT	10V	47µF	
C1895	ECA1AM470GB	ELECT	10V	7µF	
C1896	ECUV1H104ZFX	S.M.CAP	50V	100nF	
C1897	ECA1AM330GB	ELECT	10V	33µF	
C1901	ECQV1H105JZ	FILM	50V	1µF	
C1902	ECQV1H105JZ	FILM	50V	1µF	
C1903	ECA1EM470GB	ELECT	25V	47µF	
C1904	ECKC1H103JB	CERAMIC	50V	10nF	
C1905	ECQV1H105JZ	FILM	50V	1µF	

Ref No.	Part No.	Description			
C1906	ECQV1H105JZ	FILM	50V	1μF	
C2001	ECA1CM100GB	ELECT	16V	10μF	
C2002	ECUV1H104ZFX	S.M.CAP	50V	100nF	
C2003	ECUV1H104ZFX	S.M.CAP	50V	100nF	
C2004	ECUV1H102JCX	S.M.CAP	50V	1nF	
C2005	ECUV1H391JCX	S.M.CAP	50V	390pF	
C2006	ECUV1H391JCX	S.M.CAP	50V	390pF	
C2007	ECUV1H102JCX	S.M.CAP	50V	1nF	
C2008	ECUV1H102JCX	S.M.CAP	50V	1nF	
C2009	ECUV1H102JCX	S.M.CAP	50V	1nF	
C2010	ECUV1H102JCX	S.M.CAP	50V	1nF	
C2011	ECUV1H102JCX	S.M.CAP	50V	1nF	
C2012	ECUV1H102JCX	S.M.CAP	50V	1nF	
C2014	ECQM1H334J	FILM	50V	330nF	
C2017	ECA1CM100GB	ELECT	16V	10μF	
C2018	ECA1CM100GB	ELECT	16V	10μF	
C2019	ECA1CM221GB	ELECT	16V	220μF	
C2020	ECUV1H104ZFX	S.M.CAP	50V	100nF	
C2021	ECUV1H104ZFX	S.M.CAP	50V	100nF	
C2022	ECA1HM3R3GB	ELECT	50V	3.3μF	
C2023	ECUV1H471JCX	S.M.CAP	50V	470pF	
C2024	ECUV1H471JCX	S.M.CAP	50V	470pF	
C2025	ECUV1H221JCX	S.M.CAP	50V	220pF	
C2026	ECUV1H221JCX	S.M.CAP	50V	220pF	
C2027	ECUV1H221JCX	S.M.CAP	50V	220pF	
C2028	ECUV1H221JCX	S.M.CAP	50V	220pF	
C2029	ECUV1H221JCX	S.M.CAP	50V	220pF	
C2030	ECUV1H221JCX	S.M.CAP	50V	220pF	
C2031	ECUV1H104ZFX	S.M.CAP	50V	100nF	
C2032	ECA1CM100GB	ELECT	16V	10μF	
C2034	ECUV1H070DCX	S.M.CAP	50V	7pF	
C2035	ECUV1H560JCX	S.M.CAP	50V	56pF	
C2036	ECUV1H100DCX	S.M.CAP	50V	10pF	
C2037	ECUV1H220JCX	S.M.CAP	50V	22pF	
C2039	ECUV1H070DCX	S.M.CAP	50V	7pF	
C2040	ECUV1H560JCX	S.M.CAP	50V	56pF	
C2041	ECUV1H560JCX	S.M.CAP	50V	56pF	
C2042	ECUV1H104ZFX	S.M.CAP	50V	100nF	
C2043	ECA1CM100GB	ELECT	16V	10μF	
C2044	ECUV1H010CCX	S.M.CAP	50V	1pF	
C2045	ECUV1H010CCX	S.M.CAP	50V	1pF	
C2050	ECUV1H223ZFX	S.M.CAP	50V	22nF	
C2051	ECUV1H223ZFX	S.M.CAP	50V	22nF	
C2052	ECUV1H103ZFX	S.M.CAP	50V	10nF	
C2053	ECUV1H103ZFX	S.M.CAP	50V	10nF	
C2054	ECA1CM331B	ELECT	16V	330μF	
C2055	ECA1CM102B	ELECT	16V	1.0nF	
C2058	ECUV1H683ZFX	S.M.CAP	50V	68nF	
C2059	ECUV1H102KBX	S.M.CAP	50V	1nF	
C2060	ECUV1H102KBX	S.M.CAP	50V	1nF	
C2351	ECA1CM471GB	ELECT	16V	470μF	
C2352	ECA1CM471GB	ELECT	16V	470μF	
C2353	ECA1HM4R7GB	ELECT	50V	4.7μF	
C2354	ECKC1H103JB	CERAMIC	50V	10nF	
C2355	ECA1HMR33GB	ELECT	50V	0.33μF	
C2356	ECKC1H103JB	CERAMIC	50V	10nF	
C2360	ECKC1H103JB	CERAMIC	50V	10nF	
C2361	ECA1CM471GB	ELECT	16V	470μF	
C2362	ECA1CM471GB	ELECT	16V	470μF	
C2363	ECA1HM4R7GB	ELECT	50V	4.7μF	
C2364	ECKC1H103JB	CERAMIC	50V	10nF	
C2365	ECA1HMR33GB	ELECT	50V	0.33μF	
C2366	ECKC1H103JB	CERAMIC	50V	10nF	
C2401	ECA1HM101GB	ELECT	50V	100μF	
C2402	ECUV1H682KBX	S.M.CAP	50V	6.8nF	
C2405	ECA1HM4R7GB	ELECT	50V	4.7μF	
C2406	ECA1HM4R7GB	ELECT	50V	4.7μF	
C2407	ECA1HM4R7GB	ELECT	50V	4.7μF	
C2408	ECA1HM4R7GB	ELECT	50V	4.7μF	
C2409	ECA1HM4R7GB	ELECT	50V	4.7μF	
C2415	ECUV1H103ZFX	S.M.CAP	50V	10nF	
C2418	ECQM1H104J	FILM	50V	100nF	

Ref No.	Part No.	Description			
C2420	ECUV1H104ZFX	S.M.CAP	50V	100nF	
C2421	ECA1HHG101B	ELECT	50V	100μF	
C2423	ECUV1H104ZFX	S.M.CAP	50V	100nF	
C2424	ECA1HHG220B	ELECT	50V	22μF	
C2426	ECUV1H101JCX	S.M.CAP	50V	100pF	
C2429	ECUV1H101JCX	S.M.CAP	50V	100pF	
C2432	ECUV1H561JCX	S.M.CAP	50V	560pF	
C2433	ECUV1H561JCX	S.M.CAP	50V	560pF	
C2434	ECUV1H561JCX	S.M.CAP	50V	560pF	
C2435	ECUV1H561JCX	S.M.CAP	50V	560pF	
C2436	ECUV1H561JCX	S.M.CAP	50V	560pF	
C2437	ECA1HM100GB	ELECT	50v	10μF	
C2438	ECQB1H223K	FILM	50V	22nF	
C2439	ECA1HM010GB	ELECT	50V	1μF	
C2440	ECA1HM100GB	ELECT	50v	10μF	
C2441	ECUV1H682KBX	S.M.CAP	50V	6.8nF	
C2442	ECUV1H682KBX	S.M.CAP	50V	6.8nF	
C2443	ECUV1H050CCX	S.M.CAP	50V	5pF	
C2444	ECUV1H682KBX	S.M.CAP	50V	6.8nF	
C2445	ECQB1H473K	FILM	50V	47nF	
C2446	ECQB1H473K	FILM	50V	47nF	
C2449	ECA1HM100GB	ELECT	50v	10μF	
C2450	ECUV1H222KBX	S.M.CAP	50V	2.2nF	
C2451	ECEA1HN010UB	ELECT	50V	1μF	
C2455	ECA1HM010GB	ELECT	50V	1μF	
C2456	ECA1HM330B	ELECT	50V	33μF	
C2459	ECA1HM010GB	ELECT	50V	1μF	
C2460	ECA1HM010GB	ELECT	50V	1μF	
C2461	ECA1HM100GB	ELECT	50v	10μF	
C2464	ECA1HM100GB	ELECT	50v	10μF	
C2467	ECA1HM100GB	ELECT	50v	10μF	
C2468	ECA1HM010GB	ELECT	50V	1μF	
C2469	ECA1HM010GB	ELECT	50V	1μF	
C2470	ECA1HM100GB	ELECT	50v	10μF	
C2471	ECA1CM471GB	ELECT	16V	470μF	
C2472	ECA1HM100GB	ELECT	50v	10μF	
C2473	ECUV1H103ZFX	S.M.CAP	50V	10nF	
C2474	ECUV1H103ZFX	S.M.CAP	50V	10nF	
C2475	ECUV1H330JCX	S.M.CAP	50V	33pF	
C2476	ECUV1H330JCX	S.M.CAP	50V	33pF	
C2477	ERJ6GEYJ183	S.M.CARB	0.1W	5% 18KΩ	
C2478	ECA1HM220GB	ELECT	50V	22μF	
C2479	ECEA1HN010UB	ELECT	50V	1μF	
C2480	ECEA1HN010UB	ELECT	50V	1μF	
C2481	ECEA1HN010UB	ELECT	50V	1μF	
C2482	ECEA1HN010UB	ELECT	50V	1μF	
C2484	ECUV1H103KBX	S.M.CAP	50V	10nF	
C2485	ECA1HMR22GB	ELECT	50V	0.22μF	
C2486	ECUV1H103KBX	S.M.CAP	50V	10nF	
C2487	ECA1HMR22GB	ELECT	50V	0.22μF	
C2488	ECUV1H103KBX	S.M.CAP	50V	10nF	
C2489	ECUV1H104ZFX	S.M.CAP	50V	100nF	
C2490	ECEA1HU101	ELECT	50V	100μF	
C2491	ECA1HM100GB	ELECT	50v	10μF	
C2492	ECUV1H103KBX	S.M.CAP	50V	10nF	
C2493	ECA1HMR22GB	ELECT	50V	0.22μF	
C2494	ECA1HM4R7GB	ELECT	50V	4.7μF	
C2495	ECA1HM100GB	ELECT	50v	10μF	
C2502	ECOS2GA101BB	ELECT	400V	100μF	
C2504	ECKC3D471JB	CERAMIC	2KV	470pF	Δ
C2505	ECKC2H103J	CERAMIC	50V	10nF	Δ
C2506	ECQB1H333J	FILM	50V	33nF	
C2507	ECQB1H683K	FILM	50V	68nF	
C2508	ECA1CM221GB	ELECT	16V	220μF	
C2509	ECA1CM221GB	ELECT	16V	220μF	
C2510	ECKCWS471J	CERAMIC	400V	470pF	
C2512	ECA1CHG102B	ELECT	16V	1.0nF	
C2513	ECA1HM010GB	ELECT	50V	1μF	
C2514	ECA1HM010GB	ELECT	50V	1μF	
C2517	ECKC3A471J	CERAMIC	1KV	470pF	Δ
C2521	ECQM1H104J	FILM	50V	100nF	

Ref No.	Part No.	Description			
C2522	ECEA1HN010UB	ELECT	50V	1μF	
C2523	ECUV1H101JCX	S.M.CAP	50V	100pF	
C2524	ECA1HM330B	ELECT	50V	33μF	
C2525	ECUV1H103ZFX	S.M.CAP	50V	10nF	
C2526	ECA1VM102GB	ELECT	35V	1nF	
C2527	ECUV1H222KBX	S.M.CAP	50V	2.2nF	
C2528	ECA1VM102GB	ELECT	35V	1nF	
C2529	ECUV1H103ZFX	S.M.CAP	50V	10nF	
C2531	ECQM1H474J	FILM	50V	470nF	
C2532	ECEA1HN010UB	ELECT	50V	1μF	
C2533	ECUV1H101JCX	S.M.CAP	50V	100pF	
C2534	ECA1HM330B	ELECT	50V	33μF	
C2535	ECUV1H103ZFX	S.M.CAP	50V	10nF	
C2536	ECA1VM221B	ELECT	35V	220μF	
C2537	ECUV1H222KBX	S.M.CAP	50V	2.2nF	
C2538	ECA1VM101GB	ELECT	35V	100μF	
C2539	ECUV1H103ZFX	S.M.CAP	50V	10nF	
C2541	ECQM1H474J	FILM	50V	470nF	
C2542	ECUV1H332KBX	S.M.CAP	50V	3.3nF	
C2543	ECUV1H332KBX	S.M.CAP	50V	3.3nF	
C2544	ECUV1H223ZFX	S.M.CAP	50V	22nF	
C2545	ECUV1H473ZFX	S.M.CAP	50V	47nF	
C2546	ECA1CM221GB	ELECT	16V	220μF	
C2547	ECA1HM100GB	ELECT	50v	10μF	
C2548	ECA1HM100GB	ELECT	50v	10μF	
C2549	ECA1HM100GB	ELECT	50v	10μF	
C2550	ECA1HM100GB	ELECT	50v	10μF	
C2551	ECA1CM221GB	ELECT	16V	220μF	
C2552	ECEA1VN100UB	ELECT	35V	10μF	
C2553	ECEA1VN100UB	ELECT	35V	10μF	
C2554	ECUV1H104ZFX	S.M.CAP	50V	100nF	
C2555	ECUV1H104ZFX	S.M.CAP	50V	100nF	
C2556	ECA1HMR47GB	ELECT	50V	0.47μF	
C2557	ECA1HMR47GB	ELECT	50V	4.7μF	
C2558	ECA1HMR47GB	ELECT	50V	0.47μF	
C2559	ECA1HMR47GB	ELECT	50V	4.7μF	
C2560	ECUV1C154KBX	S.M.CAP	16V	0.15μF	
C2561	ECA1HM3R3GB	ELECT	50V	3.3μF	
C2562	ECUV1C154KBX	S.M.CAP	16V	0.15μF	
C2563	ECUV1C154KBX	S.M.CAP	16V	0.15μF	
C2564	ECA1HM3R3GB	ELECT	50V	3.3μF	
C2565	ECUV1C154KBX	S.M.CAP	16V	0.15μF	
C2566	ECA1HM4R7GB	ELECT	50V	4.7μF	
C2567	ECA1HMR47GB	ELECT	50V	0.47μF	
C2568	ECA1HM4R7GB	ELECT	50V	4.7μF	
C2569	ECA1HMR47GB	ELECT	50V	0.47μF	
C2570	ECUV1H104ZFX	S.M.CAP	50V	100nF	
C2571	ECUV1H104ZFX	S.M.CAP	50V	100nF	
C2572	ECA1HM470GB	ELECT	50V	47μF	
C2573	ECQM1H474J	FILM	50V	470nF	
C2574	ECUV1H681JCX	S.M.CAP	50V	680pF	
C2575	ECA1HM010GB	ELECT	50V	1μF	
C2576	ECA1HM010GB	ELECT	50V	1μF	
C2577	ECA1CM221GB	ELECT	16V	220μF	
C2578	ECA1HM2R2GB	ELECT	50V	2.2μF	
C2579	ECUV1H103ZFX	S.M.CAP	50V	10nF	
C2580	ECEA1HN010UB	ELECT	50V	1μF	
C2581	ECA1HM100GB	ELECT	50v	10μF	
C2582	ECUV1H103ZFX	S.M.CAP	50V	10nF	
C2583	ECA1CM221GB	ELECT	16V	220μF	
C2584	ECA1HM010GB	ELECT	50V	1μF	
C2585	ECUV1H333KBX	S.M.CAP	50V	33nF	
C2586	ECUV1H152JCX	S.M.CAP	50V	1.5pF	
C2587	ECUV1H333KBX	S.M.CAP	50V	33nF	
C2588	ECA1CM221GB	ELECT	16V	220μF	
C2589	ECUV1H333JCX	S.M.CAP	50V	33pF	
C2590	ECUV1H333JCX	S.M.CAP	50V	33pF	
C2591	ECEA1HN3R3UB	ELECT	50V	3R3μF	
C2594	ECEA1HN3R3UB	ELECT	50V	3R3μF	
C2595	ECEA1HN010UB	ELECT	50V	1μF	
C2596	ECUV1H103ZFX	S.M.CAP	50V	10nF	
C2597	ECA1CM471GB	ELECT	16V	470μF	

Ref No.	Part No.	Description			
C2700	ECUV1H102KBX	S.M.CAP	50V	1nF	
C2701	ECEA1HN010UB	ELECT	50V	1μF	
C2702	ECA1CM470GB	ELECT	16V	47μF	
C2703	ECEA1HN010UB	ELECT	50V	1μF	
C2704	ECEA1HN010UB	ELECT	50V	1μF	
C2705	ECUV1H101JCX	S.M.CAP	50V	100pF	
C2706	ECUV1H101JCX	S.M.CAP	50V	100pF	
C2707	ECUV1H101JCX	S.M.CAP	50V	100pF	
C2708	ECEA1HN010UB	ELECT	50V	1μF	
C2709	ECQB1H153K	FILM	50V	15nF	
C2710	ECA1HM010GB	ELECT	50V	1μF	
C2711	ECQB1H153K	FILM	50V	15nF	
C2712	ECQM1222JZ	FILM	100V	2.2nF	
C2713	ECQV1H105JZ	FILM	50V	1μF	
C2714	ECA1CM331B	ELECT	16V	330μF	
C2715	ECQB1H103J	FILM	50V	10nF	
C2716	ECQM1H154J	FILM	50V	150nF	
C2717	ECQB1H683K	FILM	50V	68nF	
C2718	ECQB1H222J	FILM	50V	2200pF	
C2719	ECQB1H333J	FILM	50V	33nF	
C2720	ECQB1H332K	FILM	50V	3.3nF	
C2722	ECKC3A182J	CERAMIC	1.0KV	1.8nF	
C2723	ECEA1HN100UB	ELECT	50V	10μF	
C2724	ECKC3A471J	CERAMIC	1KV	470pF	Δ
C2725	ECKC3A151J	CERAMIC	1.0KV	150pF	
C2726	ECKC3A331J	CERAMIC	1000V	330pF	Δ
C2727	ECA1HM010GB	ELECT	50V	1μF	
C2728	ECQM4223JZW	FILM	400V	22nF	
C2729	ECQM4223JZW	FILM	400V	22nF	
C2731	ECKC3D101J	CERAMIC	2.0KV	100pF	
C2732	ECEA160V33ZE	ELECT	160V	33μF	
C2733	ECKC3A471J	CERAMIC	1KV	470pF	Δ
C2734	ECA1CM331B	ELECT	16V	330μF	
C2735	ECA1EM101GB	ELECT	25V	100μF	
C2736	ECA2EM330B	ELECT	250V	33μF	
C2737	ECQB1H104J	FILM	50V	100nF	
C2739	ECA1HM3R3GB	ELECT	50V	3.3μF	
C2740	ECA1CM471GB	ELECT	16V	470μF	
C2741	ECA1HMR47GB	ELECT	50V	0.47μF	
C2742	ECEA1HN010UB	ELECT	50V	1μF	
C2743	ECKC1H101J	CERAMIC	50V	100pF	
C2744	ECQB1H103J	FILM	50V	10nF	
C2745	ECA1HM100GB	ELECT	50v	10μF	
C2746	ECQB1H333J	FILM	50V	33nF	
C2747	ECKC3D102J	CERAMIC	2KV	1nF	Δ
C2748	ECQM1H334J	FILM	50V	330nF	
C2749	ECQM1H684J	FILM	50V	680nF	
C2750	ECKC1H103JB	CERAMIC	50V	10nF	
C2751	ECQM1H104J	FILM	50V	100nF	
C2752	ECQB1H103J	FILM	50V	10nF	
C2753	ECA1HM3R3GB	ELECT	50V	3.3μF	
C2754	ECKC1H103JB	CERAMIC	50V	10nF	
C2755	ECQB1H563K	FILM	50V	56nF	
C2801	ECA1HM010GB	ELECT	50V	1μF	
C2802	ECA1HM010GB	ELECT	50V	1μF	
C2803	ECA1HM010GB	ELECT	50V	1μF	
C2804	ECA1HM010GB	ELECT	50V	1μF	
C2805	ECA1CM100GB	ELECT	16V	10μF	
C2806	ECA1HM010GB	ELECT	50V	1μF	
C2807	ECUV1H222KBX	S.M.CAP	50V	2.2nF	
C2808	ECA1HM010GB	ELECT	50V	1μF	
C2809	ECUV1H222KBX	S.M.CAP	50V	2.2nF	
C2810	ECA1HM010GB	ELECT	50V	1μF	
C2811	ECUV1H222KBX	S.M.CAP	50V	2.2nF	
C2812	ECA1HM010GB	ELECT	50V	1μF	
C2813	ECUV1H222KBX	S.M.CAP	50V	2.2nF	
C2814	ECA1HM101GB	ELECT	50V	100μF	
C2815	ECA1CM471GB	ELECT	16V	470μF	
C3001	ECKC1H561J	CERAMIC	50V	560pF	
C3002	ECKC1H561J	CERAMIC	50V	560pF	
C3101	ECEA1HN4R7UB	ELECT	50V	4.7μF	

Ref No.	Part No.	Description			
C3105	ECUV1H221JCX	S.M.CAP	50V	220pF	
C3106	ECUV1H561JCX	S.M.CAP	50V	560pF	
C3109	ECUV1H221JCX	S.M.CAP	50V	220pF	
C3110	ECUV1H561JCX	S.M.CAP	50V	560pF	
C3111	ECUV1H102JCX	S.M.CAP	50V	1nF	
C3112	ECA1HM470GB	ELECT	50V	47µF	
C3113	ECA1HM470GB	ELECT	50V	47µF	
C3114	ECA1CM470GB	ELECT	16V	47µF	
C3115	ECEA1HNR47UB	ELECT	50V	0.47µF	
C3116	ECA1HM470GB	ELECT	50V	47µF	
C3117	ECEA1HN4R7UB	ELECT	50V	4.7µF	
C3118	ECEA1HN4R7UB	ELECT	50V	4.7µF	
C3119	ECA1HM470GB	ELECT	50V	47µF	
C3120	ECA1CM470GB	ELECT	16V	47µF	
C3121	ECUV1H221JCX	S.M.CAP	50V	220pF	
C3122	ECUV1H561JCX	S.M.CAP	50V	560pF	
C3123	ECEA1HN4R7UB	ELECT	50V	4.7µF	
C3124	ECUV1H221JCX	S.M.CAP	50V	220pF	
C3125	ECUV1H561JCX	S.M.CAP	50V	560pF	
C3126	ECEA1HN4R7UB	ELECT	50V	4.7µF	
C3127	ECEA1HN4R7UB	ELECT	50V	4.7µF	
C3128	ECEA1HN4R7UB	ELECT	50V	4.7µF	
C3129	ECUV1H102JCX	S.M.CAP	50V	1nF	
C3130	ECEA1HN4R7UB	ELECT	50V	4.7µF	
C3131	ECUV1H473KBX	S.M.CAP	50V	47nF	
C3132	ECA1CM470GB	ELECT	16V	47µF	
C3133	ECA1CM470GB	ELECT	16V	47µF	
C3134	ECA1CM470GB	ELECT	16V	47µF	
C3135	ECA1HMR47GB	ELECT	50V	0.47µF	
C3136	ECA1CM470GB	ELECT	16V	47µF	
C3137	ECA1HM470GB	ELECT	50V	47µF	
C3138	ECA1HM470GB	ELECT	50V	47µF	
C3143	ECUV1H221JCX	S.M.CAP	50V	220pF	
C3144	ECUV1H561JCX	S.M.CAP	50V	560pF	
C3145	ECUV1H561JCX	S.M.CAP	50V	560pF	
C3146	ECUV1H221JCX	S.M.CAP	50V	220pF	
C3147	ECUV1H561JCX	S.M.CAP	50V	560pF	
C3148	ECA1HM4R7GB	ELECT	50V	4.7µF	
C3149	ECUV1H221JCX	S.M.CAP	50V	220pF	
C3150	ECA1HM4R7GB	ELECT	50V	4.7µF	
C3151	ECUV1H221JCX	S.M.CAP	50V	220pF	
C3152	ECUV1H561JCX	S.M.CAP	50V	560pF	
C3153	ECUV1H104ZFX	S.M.CAP	50V	100nF	
C3154	ECUV1H104ZFX	S.M.CAP	50V	100nF	
C3155	ECA1CM470GB	ELECT	16V	47µF	
C3156	ECA1CM470GB	ELECT	16V	47µF	
C3158	ECUV1H102JCX	S.M.CAP	50V	1nF	
C3159	ECUV1H121JCX	S.M.CAP	50V	120pF	
C3160	ECUV1H104ZFX	S.M.CAP	50V	100nF	
C3162	ECA1CM471GB	ELECT	16V	470pF	
C3163	ECA1HMR47GB	ELECT	50V	0.47µF	
C3164	ECUV1H104ZFX	S.M.CAP	50V	100nF	
C3165	ECA1HM470GB	ELECT	50V	47µF	
C3167	ECUV1H561JCX	S.M.CAP	50V	560pF	
C3168	ECUV1H561JCX	S.M.CAP	50V	560pF	
C3169	ECUV1H102JCX	S.M.CAP	50V	1nF	
C3170	ECUV1H221JCX	S.M.CAP	50V	220pF	
C3172	ECUV1H221JCX	S.M.CAP	50V	220pF	
C3173	ECA1HMR47GB	ELECT	50V	47µF	
C3174	ECUV1H221JCX	S.M.CAP	50V	220pF	
C3175	ECUV1H561JCX	S.M.CAP	50V	560pF	
C3177	ECUV1H561JCX	S.M.CAP	50V	560pF	
C3178	ECUV1H221JCX	S.M.CAP	50V	220pF	
C3180	ECA1HMR47GB	ELECT	50V	0.47µF	
C3181	ERJ6GEY0R00	S.M.CARB	0.1W	5%	0Ω
C3182	ECUV1H102JCX	S.M.CAP	50V	1nF	
C3183	ERJ6GEY0R00	S.M.CARB	0.1W	5%	0Ω
C3184	ECUV1H473KBX	S.M.CAP	50V	47nF	
C3185	ERJ6GEY0R00	S.M.CARB	0.1W	5%	0Ω
C3186	ECEA1HNR47UB	ELECT	50V	0.47µF	
C3187	ECA1HM470GB	ELECT	50V	47µF	
C3188	ECEA1CN470	ELECT	16V	47µF	

Ref No.	Part No.	Description			
C3189	ECEA1CN470	ELECT	16V	47µF	
C3190	ECA1HMR47GB	ELECT	50V	0.47µF	
C3191	ECA1HM470GB	ELECT	50V	47µF	
C3192	ECUV1H473KBX	S.M.CAP	50V	47nF	
C3193	ECUV1H473KBX	S.M.CAP	50V	47nF	
C3194	ECA1HM470GB	ELECT	50V	47µF	
C3195	ECUV1H391JCX	S.M.CAP	50V	390pF	
C3196	ECEA1CN330	ELECT	16V	33µF	
C3201	ECA1HM010GB	ELECT	50V	1µF	
C3202	ECUV1H473ZFX	S.M.CAP	50V	47nF	
C3203	ECA1CM100GB	ELECT	16V	10µF	
C3204	ECUV1H473ZFX	S.M.CAP	50V	47nF	
C3351	ECA1HM101GB	ELECT	50V	100µF	
C3501	ECUV1H220JCX	S.M.CAP	50V	22pF	
C3502	ECUV1H220JCX	S.M.CAP	50V	22pF	
C3503	ECEA1HKN010	ELECT	50V	1µF	
C3504	ECUV1H224ZFX	S.M.CAP	50V	0.22µF	
C3510	ECUV1H103ZFX	S.M.CAP	50V	10nF	
C3511	ECA1HM101GB	ELECT	50V	100µF	
C3512	ECUV1H104ZFX	S.M.CAP	50V	100nF	
C3514	ECUV1H104ZFX	S.M.CAP	50V	100nF	
C3515	ECA0JM331GB	ELECT	6.3V	330µF	
C3516	ECUV1H104ZFX	S.M.CAP	50V	100nF	
C3521	ECA1HM101GB	ELECT	50V	100µF	
C3522	ECUV1H104ZFX	S.M.CAP	50V	100nF	
C3801	ECA1HM010GB	ELECT	50V	1µF	
C3802	ECUV1H104ZFX	S.M.CAP	50V	100nF	
C3803	ECA1CM471GB	ELECT	16V	470µF	
C3807	ECUV1H104ZFX	S.M.CAP	50V	100nF	
C3808	ECUV1H104ZFX	S.M.CAP	50V	100nF	
C3809	ECA0JM101G	ELECT	6.3V	100µF	
C3810	ECUV1H103KBX	S.M.CAP	50V	10nF	
C3812	ECA1CM221GB	ELECT	16V	220µF	

DIODES

D001	MA4020	DIODE			
D002	MA4020	DIODE			
D103	BA582	DIODE			
D104	BA582	DIODE			
D251	MA165TA5	DIODE	1SS133T-77		
D252	MA165TA5	DIODE	1SS133T-77		
D253	MA165TA5	DIODE	1SS133T-77		
D254	MA165TA5	DIODE	1SS133T-77		
D351	ERA15-04V3	COIL			
D352	ERA15-04V3	COIL			
D361	ERA15-04V3	COIL			
D362	ERA15-04V3	COIL			
D371	ERA15-04V3	COIL			
D372	ERA15-04V3	COIL			
D373	MTZJT-7715A	DIODE			
D374	MTZJT-7715A	DIODE			
D375	MTZJT-7715A	DIODE			
D387	MA2160LFS	DIODE			
D401	MA165TA5	DIODE	1SS133T-77		
D451	MA4056	DIODE			
D452	MA2330-ALF	DIODE			
D453	TVSEM01ZV0	DIODE			
D457	1SS252T-77	DIODE			
D502	1SS254T-77	DIODE			
D503	EU02	DIODE			
D504	EU02	DIODE			
D531	1SS254T-77	DIODE			
D532	1SS254T-77	DIODE			
D533	1SS254T-77	DIODE			
D534	1SS254T-77	DIODE			
D551	EU02	DIODE			
D556	AU02V0	DIODE			
D557	ERC91-02L9	DIODE			
D558	AU02V0	DIODE			
D559	MTZJT-7736A	DIODE			
D560	1SS252T-77	DIODE			

Ref No.	Part No.	Description
D561	1SS254T-77	DIODE
D563	RH3GLF102	DIODE
D571	FMV-3GULF027	DIODE
D572	RU3NLFA1	DIODE
D573	1SS254T-77	DIODE
D574	1SS252T-77	DIODE
D575	1SS252T-77	DIODE
D576	TMPG43G3	DIODE
D602	MA165TA5	DIODE 1SS133T-77
D603	MA165TA5	DIODE 1SS133T-77
D604	MA4062	DIODE
D704	MA4150	DIODE
D705	MA165TA5	DIODE 1SS133T-77
D706	MA165TA5	DIODE 1SS133T-77
D707	MA188TA	DIODE
D709	PC123FY2	DIODE
D803	MTZJT-7712C	DIODE
D806	TF361MALF3	DIODE
D807	RBV-608LF-B	DIODE
D808	1SS254T-77	DIODE
D809	ERA22-02V3	DIODE
D810	MA2180BLFS	DIODE
D812	MTZJT-775.6B	DIODE
D813	MA700TA5	DIODE
D814	AU01ZV0	DIODE
D815	PC123FY2	DIODE
D817	D5L60F4015	DIODE
D818	TMPG10G3	DIODE
D819	ERA81004V3	DIODE
D820	MA4100	DIODE
D821	EU02AV0	DIODE
D845	1SS254T-77	DIODE
D846	TVSS1WBS20	DIODE
D847	ERA15-01V1	DIODE
D848	ERB32-02E	DIODE RU30LFS1
D849	5JUZ47	DIODE
D850	EU02	DIODE
D851	ERC20M8ZF189	DIODE
D852	MA4091	DIODE
D853	EU02	DIODE
D854	1SS254T-77	DIODE
D855	D10SC6MRL	DIODE
D857	FML22SLF610	DIODE
D860	1SS254T-77	DIODE
D861	MTZJT-7713B	DIODE
D901	1SS254T-77	DIODE
D902	1SS254T-77	DIODE
D903	1SS254T-77	DIODE
D1051	LN81RPHL	DIODE
D1052	AU01V0	DIODE
D1053	AU01V0	DIODE
D1054	AU01V0	DIODE
D1055	AU01V0	DIODE
D1056	AU01V0	DIODE
D1057	AU01V0	DIODE
D1102	MA4051	DIODE
D1107	MTZJT-775.6A	DIODE
D1108	1SS254T-77	DIODE
D1109	1SS254T-77	DIODE
D1113	MA4051	DIODE
D1552	RLS72TE-11	DIODE OR PMLL4148
D1824	MA4051	DIODE
D2005	MA723TA5	DIODE
D2006	MA723TA5	DIODE
D2421	1SS355TE-17	DIODE
D2422	1SS355TE-17	DIODE
D2480	1SS355TE-17	DIODE
D2501	D5L60F4015	DIODE
D2502	EG01CV0	DIODE
D2503	EU02	DIODE
D2504	TVSEH1V0	DIODE
D2505	MTZJT-778.2A	DIODE

Ref No.	Part No.	Description
D2506	EU02	DIODE
D2507	EU02	DIODE
D2510	EU02	DIODE
D2511	RU4AMLF-M1	DIODE
D2512	1SS355TE-17	DIODE
D2513	1SS254T-77	DIODE
D2514	1SS355TE-17	DIODE
D2515	1SS355TE-17	DIODE
D2517	1SS254T-77	DIODE
D2518	1SS254T-77	DIODE
D2519	1SS254T-77	DIODE
D2520	1SS254T-77	DIODE
D2521	1SS254T-77	DIODE
D2522	1SS254T-77	DIODE
D2523	1SS254T-77	DIODE
D2524	MTZJT-7712C	DIODE
D2525	MTZJT-7712C	DIODE
D2526	MTZJT-7712C	DIODE
D2527	MTZJT-7712C	DIODE
D2528	UDZTE-176.8B	DIODE
D2529	1SS355TE-17	DIODE
D2530	1SS355TE-17	DIODE
D2531	1SS355TE-17	DIODE
D2701	MTZJT-779.1C	DIODE
D2707	ERA22-06V3	DIODE
D2708	ERA22-06V3	DIODE
D2709	MA165TA5	DIODE 1SS133T-77
D2710	RP1HLFA5	DIODE
D2711	RP1HLFA5	DIODE
D2712	MTZJT-7724D	DIODE
D2713	MA165TA5	DIODE 1SS133T-77
D2715	MTZJT-7710D	DIODE
D2717	MA165TA5	DIODE 1SS133T-77
D2719	PC123FY2	DIODE
D2720	MA165TA5	DIODE 1SS133T-77
D2801	RLS73TE-11	COIL
D3101	PMLL5242B	DIODE
D3104	PMLL5242B	DIODE
D3105	PMLL5242B	DIODE
D3107	PMLL5242B	DIODE
D3108	PMLL5242B	DIODE
D3109	PMLL5242B	DIODE
D3110	PMLL5242B	DIODE
D3111	PMLL5242B	DIODE
D3112	PMLL5242B	DIODE
D3115	PMLL5242B	DIODE
D3117	PMLL5242B	DIODE
D3120	RLS72TE-11	DIODE OR PMLL4148
D3121	RLS72TE-11	DIODE OR PMLL4148
D3351	1SS254T-77	DIODE
D3501	MA4030	DIODE
D3801	MA4043	DIODE
D3802	MTZJT-778.2A	DIODE
D3803	ERA81004V3	DIODE
D3805	MTZJT-779.1C	DIODE
D3806	MA165TA5	DIODE 1SS133T-77
D3807	MA165TA5	DIODE 1SS133T-77
FUSES		
F531	TR5-T1000	FUSE
F801	XBA2C50TH15	FUSE
F8011	EYF52BC	FUSE HOLDER
F8012	EYF52BC	FUSE HOLDER
INTEGRATED CIRCUITS		
IC101	TDA9814TV3	VIF
IC1051	PNA4601M04TV	LED RECEIVER
IC1101	SDA30C164-2	MICRO PROCESSOR
IC1102	S-80745AL-Z	RESET
IC1103	MN1280R	RESET

△

Ref No.	Part No.	Description
IC1104	X24C0302EL	EAROM
IC1105	27C2001-607	EPROM
IC1301	SAA4961	COMB FILTER
IC1551	SN74F04DR	CLOCK
IC1552	SDA9257	CLOCK GENERATOR
IC1581	SDA9205-2GEG	A/D CONVERTER
IC1601	UPD93213GF	DFU
IC1602	SDA9280B22GE	VIDEO PROCESSOR
IC1701	MB87D202A	VIDEO PROCESSOR
IC1721	SDA9251-2XGE	RAM
IC1722	SDA9251-2XGE	RAM
IC1723	SDA9251-2XGE	RAM
IC1724	SDA9251-2XGE	RAM
IC1725	SDA9251-2XGE	RAM
IC1726	SDA9251-2XGE	RAM
IC1727	SDA9251-2XGE	RAM
IC1801	TDA9143-N1	COLOUR DECODER
IC1802	TDA4665-V4	DELAY LINE
IC1803	SDA9187-2XGE	A/D CONVERTER
IC1841	SDA9189XGEG	PIP PROCESSOR
IC1844	L78M05MRB	5V REGULATOR
IC1901	LA6515	EARTH CORRECTION
IC2001	MSP3410DPPB4	AUDIO PROCESSOR
IC2501	STR10006-M	SWITCHABLE POWER SUPPLY
IC2502	L78M12MRB	12V REGULATOR
IC2503	L78M05MRB	5V REGULATOR
IC2505	TDA2030AV	AUDIO AMPLIFIER
IC2506	TDA2030AV	AUDIO AMPLIFIER
IC2507	LA2785	DOLBY ENCODER
IC2508	AN7809FLB	9V REGULATOR
IC2509	LV1011	DOLBY MATRIX
IC251	TDA2030AV	AUDIO AMPLIFIER
IC2511	AN5295NK	AUDIO CONTROL
IC2512	M5222P	SURROUND VOLUME CONTROL
IC2513	MC68HC-E01	MICRO-PROCESSOR
IC2514	MN1280R	RESET
IC2515	AN6554	OPERATIONAL AMPLIFIER
IC2516	AN6554	OPERATIONAL AMPLIFIER
IC2517	TDA2030AV	AUDIO AMPLIFIER
IC2518	AN6554	OPERATIONAL AMPLIFIER
IC252	TDA2030AV	AUDIO AMPLIFIER
IC2701	AN5422K	DYNAMIC FOCUS
IC2702	AN7812FLB	12V REGULATOR
IC2704	AN5560	SWITCHING
IC3101	TEA6420	AUDIO SWITCH
IC3102	TEA6415C	VIDEO SWITCH
IC3501	SDA5273S/134	MEGA TEXT
IC3502	M514256B70RS	DRAM
IC351	TDA6111	RGB OUTPUT
IC361	TDA6111	RGB OUTPUT
IC371	TDA6111	RGB OUTPUT
IC3801	AN7808LB	8V REGULATOR
IC3803	AN7805LB	5V REGULATOR
IC3804	AN7809FLB	9V REGULATOR
IC3805	AN78L08TA	8V REGULATOR
IC401	TDA9151-B	DEFLECTION CONTROL
IC451	TDA8350Q/N5	VERTICAL OUTPUT
IC601	TDA9143-N1	COLOUR DECODER
IC602	TDA4665-V4	DELAY LINE
IC603	TDA4780/V4	RGB VIDEO PROCESSOR
IC845	SE140N	ERROR AMPLIFIER
IC851	TL431ACLPM	COIL
IC852	TL431ACLPM	COIL
I2801	AN6554NSF-E2	OPERATIONAL AMPLIFIER

TERMINALS AND LINKS

JA2	ERJ6GEY0R00	S.M.CARB	0.1W	5%	0Ω
JA3	ERJ6GEY0R00	S.M.CARB	0.1W	5%	0Ω
JA5	ERJ6GEY0R00	S.M.CARB	0.1W	5%	0Ω
JA6	ERJ6GEY0R00	S.M.CARB	0.1W	5%	0Ω
JA7	ERJ6GEY0R00	S.M.CARB	0.1W	5%	0Ω

Ref No.	Part No.	Description
JA8	ERJ6GEY0R00	S.M.CARB 0.1W 5% 0Ω
JA9	ERJ6GEY0R00	S.M.CARB 0.1W 5% 0Ω
JC1	ERJ6GEY0R00	S.M.CARB 0.1W 5% 0Ω
JC2	ERJ6GEY0R00	S.M.CARB 0.1W 5% 0Ω
JC3	ERJ6GEY0R00	S.M.CARB 0.1W 5% 0Ω
JK2501	TJB8E013	6 PIN PUSH TERMINAL
JK2502	TJB8E015	RCA TERMINAL(3P)
JK2503	TJB8E014	RCA TERMINAL(2P)
JK3001	TJB16656	A.V.TERMINAL
JSB3	ERJ6GEY0R00	S.M.CARB 0.1W 5% 0Ω
JSE012	ERJ6GEY0R00	S.M.CARB 0.1W 5% 0Ω
JSE015	ERJ6GEY0R00	S.M.CARB 0.1W 5% 0Ω
JSE02	ERJ6GEY0R00	S.M.CARB 0.1W 5% 0Ω
JSE022	ERJ6GEY0R00	S.M.CARB 0.1W 5% 0Ω
JSE023	ERJ6GEY0R00	S.M.CARB 0.1W 5% 0Ω
JSE024	ERJ6GEY0R00	S.M.CARB 0.1W 5% 0Ω
JSE025	ERJ6GEY0R00	S.M.CARB 0.1W 5% 0Ω
JSE028	ERJ6GEY0R00	S.M.CARB 0.1W 5% 0Ω
JSE042	ERJ6GEY0R00	S.M.CARB 0.1W 5% 0Ω
JSE050	ERJ6GEY0R00	S.M.CARB 0.1W 5% 0Ω
JSE056	ERJ6GEY0R00	S.M.CARB 0.1W 5% 0Ω
JSE057	ERJ6GEY0R00	S.M.CARB 0.1W 5% 0Ω
JSE062	ERJ6GEY0R00	S.M.CARB 0.1W 5% 0Ω
JSE064	ERJ6GEY0R00	S.M.CARB 0.1W 5% 0Ω
JSE066	ERJ6GEY0R00	S.M.CARB 0.1W 5% 0Ω
JSE09	ERJ6GEY0R00	S.M.CARB 0.1W 5% 0Ω
JSF001	ERJ6GEY0R00	S.M.CARB 0.1W 5% 0Ω
JSF002	ERJ6GEY0R00	S.M.CARB 0.1W 5% 0Ω
JSF004	ERJ6GEY0R00	S.M.CARB 0.1W 5% 0Ω
JSF005	ERJ6GEY0R00	S.M.CARB 0.1W 5% 0Ω
JSF015	ERJ6GEY0R00	S.M.CARB 0.1W 5% 0Ω
JSF026	ERJ6GEY0R00	S.M.CARB 0.1W 5% 0Ω
JSF038	ERJ6GEY0R00	S.M.CARB 0.1W 5% 0Ω
JSF040	ERJ6GEY0R00	S.M.CARB 0.1W 5% 0Ω
JSF041	ERJ6GEY0R00	S.M.CARB 0.1W 5% 0Ω
JSF045	ERJ6GEY0R00	S.M.CARB 0.1W 5% 0Ω
JSF046	ERJ6GEY0R00	S.M.CARB 0.1W 5% 0Ω
JSF049	ERJ6GEY0R00	S.M.CARB 0.1W 5% 0Ω
JSF050	ERJ6GEY0R00	S.M.CARB 0.1W 5% 0Ω
JSF054	ERJ6GEY0R00	S.M.CARB 0.1W 5% 0Ω
JSF056	ERJ6GEY0R00	S.M.CARB 0.1W 5% 0Ω
JSF059	ERJ6GEY0R00	S.M.CARB 0.1W 5% 0Ω
JSF061	ERJ6GEY0R00	S.M.CARB 0.1W 5% 0Ω
JSF062	ERJ6GEY0R00	S.M.CARB 0.1W 5% 0Ω
JSG001	ERJ6GEY0R00	S.M.CARB 0.1W 5% 0Ω
JSG002	ERJ6GEY0R00	S.M.CARB 0.1W 5% 0Ω
JSG011	ERJ6GEY0R00	S.M.CARB 0.1W 5% 0Ω
JSG024	ERJ6GEY0R00	S.M.CARB 0.1W 5% 0Ω
JSG025	ERJ6GEY0R00	S.M.CARB 0.1W 5% 0Ω
JSG026	ERJ6GEY0R00	S.M.CARB 0.1W 5% 0Ω
JSG027	ERJ6GEY0R00	S.M.CARB 0.1W 5% 0Ω
JSG028	ERJ6GEY0R00	S.M.CARB 0.1W 5% 0Ω
JSG071	ERJ6GEY0R00	S.M.CARB 0.1W 5% 0Ω
JSG073	ERJ6GEY0R00	S.M.CARB 0.1W 5% 0Ω
JSG075	ERJ6GEY0R00	S.M.CARB 0.1W 5% 0Ω
JSH01	ERJ6GEY0R00	S.M.CARB 0.1W 5% 0Ω
JSH010	ERJ6GEY0R00	S.M.CARB 0.1W 5% 0Ω
JSH02	ERJ6GEY0R00	S.M.CARB 0.1W 5% 0Ω
J1	ERD25TC0T	CARBON 0.25W 5% 0Ω
J2	ERD25TC0T	CARBON 0.25W 5% 0Ω

COILS

LC1503	ELKTR391CA	DELAY LINE
LC1507	EXCEMT103DTM	COIL
LC1508	EXCEMT103DTM	COIL
LC1509	EXCEMT103DTM	COIL
LC1510	EXCEMT103DTM	COIL
LC1601	ELKTR391CA	DELAY LINE
LC1602	ELKTR391CA	DELAY LINE
LC1603	ELKTR391CA	DELAY LINE
LC1609	ELKTR560BA	DELAY LINE
LC1854	ELKTR391CA	DELAY LINE

Ref No.	Part No.	Description
L002	TLT047K991R	COIL
L004	TLT047K991R	COIL
L005	TLT047K991R	COIL
L102	TLT056K991R	COIL
L103	EQV7EN203B	COIL
L105	ELESNR22MA	COIL
L107	ELESNR22MA	COIL
L108	ELESNR22MA	COIL
L109	EIL7EN015Q	COIL
L110	EQL7EN022Q	COIL
L113	EIL7EN015Q	COIL
L252	EXCELSA35T	COIL
L253	EXCELSA35T	COIL
L254	EXCELSA35T	COIL
L255	EXCELSA35T	COIL
L351	SDL5000	DELAY LINE
L352	EXCELD35V	COIL
L353	ELESN6R8KA	COIL
L361	SDL5000	DELAY LINE
L362	EXCELD35V	COIL
L363	ELESN6R8KA	COIL
L370	EXCELD35V	COIL
L371	SDL5000	DELAY LINE
L372	EXCELD35V	COIL
L373	ELESN6R8KA	COIL
L381	TLT220K991R	COIL
L383	EXCELD35V	COIL
L401	EXCELD35V	COIL
L402	EXCELD35V	COIL
L451	EXCELD35V	COIL
L552	EXCELSA35T	COIL
L554	EXCELD35V	COIL
L555	EXCELD35C	COIL
L556	EXCELD35V	COIL
L571	ELC18B801L	COIL
L572	ELHKL041B	COIL
L573	ELHKL040B	COIL
L575	ELC18B331E	COIL
L576	ELC08D101E	COIL
L578	EXCELD35C	COIL
L601	TLT047K991R	COIL
L602	TLT047K991R	COIL
L603	TLT047K991R	COIL
L605	EXCELD35V	COIL
L801	ELF18D486D	COIL
L803	ELF18D856A	COIL
L804	ELF18D856A	COIL
L805	ELF18D856A	COIL
L807	EXCELSA39V	COIL
L808	EXCELSA39V	COIL
L809	EXCELD35C	COIL
L810	EXCELSA39V	COIL
L811	EXCELSA39V	COIL
L812	EXCELD35V	COIL
L813	EXCELD35V	COIL
L814	EXCELSA35T	COIL
L817	EXCELD35V	COIL
L819	EXCELSA39V	COIL
L847	EXCELSA35T	COIL
L848	EXCELSA35T	COIL
L850	EXCELSA35T	COIL
L851	EXCELSA35B	COIL
L854	ELEIE150KA	COIL
L856	EXCELSA35T	COIL
L859	EXCELSA35T	COIL
L860	EXCELSA35T	COIL
L861	EXCELSA35T	COIL
L862	EXCELSA35T	COIL
L1102	EXCELD35V	COIL
L1103	EXCELD35V	COIL
L1104	EXCELSA35T	COIL
L1105	ELEXT4R7KA	COIL

Ref No.	Part No.	Description
L1301	TLT330K991R	COIL
L1302	TLT100K991R	COIL
L1303	TLT101K991R	COIL
L1304	TLT100K991R	COIL
L1306	TLT101K991R	COIL
L1307	ERD25TC0T	CARBON 0.25W 5% 0Ω
L1501	EXCELD35V	COIL
L1502	TLT033K991R	COIL
L1503	TLT033K991R	COIL
L1504	TLT033K991R	COIL
L1552	EXCELD35V	COIL
L1553	EXCELD35V	COIL
L1575	EXCELD35V	COIL
L1576	EXCELD35V	COIL
L1601	EXCELD35V	COIL
L1602	EXCELD35V	COIL
L1603	TLT100K991R	COIL
L1604	TLT100K991R	COIL
L1605	TLT100K991R	COIL
L1606	TLT100K991R	COIL
L1607	EXCELD35V	COIL
L1641	EXCELD35V	COIL
L1701	EXCELD35V	COIL
L1721	EXCELD35V	COIL
L1722	EXCELD35V	COIL
L1801	TLT150K991R	COIL
L1802	TLT150K991R	COIL
L1803	ERD25TC0T	CARBON 0.25W 5% 0Ω
L1804	EXCELD35V	COIL
L1810	TLT470K991R	COIL
L1812	TLT150K991R	COIL
L1841	TLT150K991R	COIL
L1842	TLT150K991R	COIL
L1901	EXCELD35V	COIL
L2001	TLT047K991R	COIL
L2003	EXCELD35V	COIL
L2004	TLT068K991R	COIL
L2005	TLT068K991R	COIL
L2351	ELEBR6R8KA	COIL
L2361	ELEBR6R8KA	COIL
L2501	EXCELSA35T	COIL
L2502	EXCELSA35T	COIL
L2503	EXCELSA35T	COIL
L2504	EXCELSA35T	COIL
L2505	5770206400	COIL
L2506	5770206400	COIL
L2507	5770206400	COIL
L2508	TLT100K991R	COIL
L2509	TLT100K991R	COIL
L2510	TLT100K991R	COIL
L2511	EXCELSA35T	COIL
L2512	EXCELSA35T	COIL
L2513	EXCELSA35T	COIL
L2514	5770206400	COIL
L2701	EXCELD35V	COIL
L2702	ELC08D182E	COIL
L3001	ELEBR6R8KA	COIL
L3002	ELEBR6R8KA	COIL
L3101	ELEMV1R5MA	COIL
L3102	ELEMV1R5MA	COIL
L3103	ELEMV1R5MA	COIL
L3104	ELEMV1R5MA	COIL
L3107	ELEMV1R5MA	COIL
L3108	ELEMV1R5MA	COIL
L3109	ELEMV1R5MA	COIL
L3110	ELEMV1R5MA	COIL
L3111	ELEMV1R5MA	COIL
L3112	ELEMV1R5MA	COIL
L3113	ELEMV1R5MA	COIL
L3114	ELEMV1R5MA	COIL
L3503	EXCELD35V	COIL
L3507	EXCELD35V	COIL

Ref No.	Part No.	Description
L3509	EXCELDR35V	COIL
L3511	TLT100K991R	COIL
TRANSISTORS		
Q008	BC847B	TRANSISTOR OR 2SD601ATX
Q101	BC847B	TRANSISTOR OR 2SD601ATX
Q102	BC847B	TRANSISTOR OR 2SD601ATX
Q103	BC847B	TRANSISTOR OR 2SD601ATX
Q104	BC847B	TRANSISTOR OR 2SD601ATX
Q105	BC847B	TRANSISTOR OR 2SD601ATX
Q106	BF799E6327	CHIP TRANSISTOR
Q107	BC847B	TRANSISTOR OR 2SD601ATX
Q108	BC847B	TRANSISTOR OR 2SD601ATX
Q109	BC860B	TRANSISTOR
Q251	BC847B	TRANSISTOR OR 2SD601ATX
Q252	BC847B	TRANSISTOR OR 2SD601ATX
Q401	BC847B	TRANSISTOR OR 2SD601ATX
Q502	2SC2925STA	TRANSISTOR
Q531	BC547B	TRANSISTOR
Q532	BC547B	TRANSISTOR
Q533	BC547B	TRANSISTOR
Q534	BC547B	TRANSISTOR
Q535	BC547B	TRANSISTOR
Q551	BC547B	TRANSISTOR
Q552	2SC5144LB228	TRANSISTOR
Q553	2SC1473—RN	TRANSISTOR
Q554	2SC1473—RN	TRANSISTOR
Q572	BC547B	TRANSISTOR
Q573	BC557B	TRANSISTOR
Q574	2SD1265AOPLB	TRANSISTOR
Q577	BC547B	TRANSISTOR
Q601	BC847B	TRANSISTOR OR 2SD601ATX
Q602	BC857B	TRANSISTOR OR 2SB709ATX
Q603	BC847B	TRANSISTOR OR 2SD601ATX
Q604	BC857B	TRANSISTOR OR 2SB709ATX
Q605	BC857B	TRANSISTOR OR 2SB709ATX
Q607	BC847B	TRANSISTOR OR 2SD601ATX
Q608	BC847B	TRANSISTOR OR 2SD601ATX
Q609	BC847B	TRANSISTOR OR 2SD601ATX
Q610	BC847B	TRANSISTOR OR 2SD601ATX
Q611	BC847B	TRANSISTOR OR 2SD601ATX
Q612	BC847B	TRANSISTOR OR 2SD601ATX
Q801	2SK1489MAT	TRANSISTOR
Q803	2SD965—R	TRANSISTOR
Q804	2SA719—TA	TRANSISTOR
Q845	2SA684R	TRANSISTOR
Q846	BC547B	TRANSISTOR
Q847	BC557B	TRANSISTOR
Q848	BC547B	TRANSISTOR
Q849	2SA1018QTA	TRANSISTOR
Q850	2SD1474PLB	TRANSISTOR
Q851	BC547B	TRANSISTOR
Q852	BC547B	TRANSISTOR
Q901	BC847B	TRANSISTOR OR 2SD601ATX
Q902	BC847B	TRANSISTOR OR 2SD601ATX
Q903	BC847B	TRANSISTOR OR 2SD601ATX
Q904	BC857B	TRANSISTOR OR 2SB709ATX
Q905	BC847B	TRANSISTOR OR 2SD601ATX
Q906	BC847B	TRANSISTOR OR 2SD601ATX
Q907	BC857B	TRANSISTOR OR 2SB709ATX
Q908	2SA1535ARLB	TRANSISTOR
Q909	2SC3944ARLB	TRANSISTOR
Q1052	BC557B	TRANSISTOR
Q1101	BC847B	TRANSISTOR OR 2SD601ATX
Q1102	BC847B	TRANSISTOR OR 2SD601ATX
Q1103	BC847B	TRANSISTOR OR 2SD601ATX
Q1106	BC847B	TRANSISTOR OR 2SD601ATX
Q1107	BC847B	TRANSISTOR OR 2SD601ATX
Q1108	BC847B	TRANSISTOR OR 2SD601ATX
Q1112	2SC3757QRTX	TRANSISTOR
Q1191	BC847B	TRANSISTOR OR 2SD601ATX

Ref No.	Part No.	Description
Q1301	BC847B	TRANSISTOR OR 2SD601ATX
Q1303	BC847B	TRANSISTOR OR 2SD601ATX
Q1304	BC847B	TRANSISTOR OR 2SD601ATX
Q1501	BC847B	TRANSISTOR OR 2SD601ATX
Q1502	BC847B	TRANSISTOR OR 2SD601ATX
Q1503	BC847B	TRANSISTOR OR 2SD601ATX
Q1575	BC847B	TRANSISTOR OR 2SD601ATX
Q1642	BC847B	TRANSISTOR OR 2SD601ATX
Q1643	BC847B	TRANSISTOR OR 2SD601ATX
Q1644	BC857B	TRANSISTOR OR 2SB709ATX
Q1647	BC847B	TRANSISTOR OR 2SD601ATX
Q1648	BC857B	TRANSISTOR OR 2SB709ATX
Q1649	BC857B	TRANSISTOR OR 2SB709ATX
Q1803	BC847B	TRANSISTOR OR 2SD601ATX
Q1879	BC857B	TRANSISTOR OR 2SB709ATX
Q1880	BC857B	TRANSISTOR OR 2SB709ATX
Q1881	BC857B	TRANSISTOR OR 2SB709ATX
Q2001	BC860B	TRANSISTOR
Q2002	BC860B	TRANSISTOR
Q2003	BC860B	TRANSISTOR
Q2004	BC860B	TRANSISTOR
Q2006	BC857B	TRANSISTOR OR 2SB709ATX
Q2007	BC847B	TRANSISTOR OR 2SD601ATX
Q2351	BC547B	TRANSISTOR
Q2352	BC547B	TRANSISTOR
Q2353	BC557B	TRANSISTOR
Q2361	BC547B	TRANSISTOR
Q2362	BC547B	TRANSISTOR
Q2363	BC557B	TRANSISTOR
Q2480	BC847B	TRANSISTOR OR 2SD601ATX
Q2501	BC557B	TRANSISTOR
Q2502	2SA684R	TRANSISTOR
Q2504	BC847B	TRANSISTOR OR 2SD601ATX
Q2505	BC857B	TRANSISTOR OR 2SB709ATX
Q2506	BC847B	TRANSISTOR OR 2SD601ATX
Q2507	BC847B	TRANSISTOR OR 2SD601ATX
Q2508	BC857B	TRANSISTOR OR 2SB709ATX
Q2509	BC847B	TRANSISTOR OR 2SD601ATX
Q2510	BC857B	TRANSISTOR OR 2SB709ATX
Q2511	BC847B	TRANSISTOR OR 2SD601ATX
Q2512	BC857B	TRANSISTOR OR 2SB709ATX
Q2513	BC847B	TRANSISTOR OR 2SD601ATX
Q2514	BC847B	TRANSISTOR OR 2SD601ATX
Q2515	BC857B	TRANSISTOR OR 2SB709ATX
Q2516	BC847B	TRANSISTOR OR 2SD601ATX
Q2518	BC847B	TRANSISTOR OR 2SD601ATX
Q2701	BC547B	TRANSISTOR
Q2702	BC547B	TRANSISTOR
Q2703	BC547B	TRANSISTOR
Q2704	BC557B	TRANSISTOR
Q2705	2SK1006RF122	TRANSISTOR
Q2706	2SC4572RB	TRANSISTOR
Q2707	BC547B	TRANSISTOR
Q2708	BC547B	TRANSISTOR
Q2711	BC547B	TRANSISTOR
Q2712	BC547B	TRANSISTOR
Q2714	BC547B	TRANSISTOR
Q2715	BC547B	TRANSISTOR
Q2716	BC547B	TRANSISTOR
Q2801	BC847B	TRANSISTOR OR 2SD601ATX
Q3103	BC847B	TRANSISTOR OR 2SD601ATX
Q3104	BC847B	TRANSISTOR OR 2SD601ATX
Q3105	BC847B	TRANSISTOR OR 2SD601ATX
Q3106	BC847B	TRANSISTOR OR 2SD601ATX
Q3107	BC857B	TRANSISTOR OR 2SB709ATX
Q3108	BC847B	TRANSISTOR OR 2SD601ATX
Q3109	BC847B	TRANSISTOR OR 2SD601ATX
Q3110	BC847B	TRANSISTOR OR 2SD601ATX
Q3113	BC847B	TRANSISTOR OR 2SD601ATX
Q3114	BC847B	TRANSISTOR OR 2SD601ATX
Q3115	BC857B	TRANSISTOR OR 2SB709ATX
Q3201	BC847B	TRANSISTOR OR 2SD601ATX

Ref No.	Part No.	Description
Q3351	BC847B	TRANSISTOR OR 2SD601ATX
Q3352	BC857B	TRANSISTOR OR 2SB709ATX
Q3501	BC847B	TRANSISTOR OR 2SD601ATX
Q3502	BC847B	TRANSISTOR OR 2SD601ATX
Q3503	2SC3130TX	TRANSISTOR
Q3801	2SD1474PLB	TRANSISTOR

RESISTOR

RL571	TSEH8012	RELAY		
RL806	TSE1885-1	TRANSISTOR		
R003	ERJ6GEYJ223	S.M.CARB 0.1W	5%	22KΩ
R006	ERJ6GEYJ393	S.M.CARB 0.1W	5%	39KΩ
R011	ERJ6GEYJ101	S.M.CARB 0.1W	5%	100Ω
R012	ERJ6GEYJ101	S.M.CARB 0.1W	5%	100Ω
R101	ERJ6GEYJ102	S.M.CARB 0.1W	5%	1KΩ
R102	ERJ6GEYJ101	S.M.CARB 0.1W	5%	100Ω
R103	ERJ6GEYJ103	S.M.CARB 0.1W	5%	10KΩ
R104	ERJ6GEY0R00	S.M.CARB 0.1W	5%	0Ω
R105	ERJ6GEYJ331	S.M.CARB 0.1W	5%	330Ω
R106	ERJ6GEYJ680	S.M.CARB 0.1W	5%	68Ω
R107	ERJ6GEYJ123	S.M.CARB 0.1W	5%	12KΩ
R109	ERJ6GEYJ102	S.M.CARB 0.1W	5%	1KΩ
R110	ERJ6GEYJ103	S.M.CARB 0.1W	5%	10KΩ
R111	ERJ6GEYJ331	S.M.CARB 0.1W	5%	330Ω
R113	ERJ6GEY0R00	S.M.CARB 0.1W	5%	0Ω
R115	ERJ6GEYJ121	S.M.CARB 0.1W	5%	120Ω
R117	ERJ6GEYJ683	S.M.CARB 0.1W	5%	68KΩ
R118	ERJ6GEYJ151	S.M.CARB 0.1W	5%	150Ω
R119	ERJ6GEY0R00	S.M.CARB 0.1W	5%	0Ω
R120	ERJ6GEYJ223	S.M.CARB 0.1W	5%	22KΩ
R121	ERJ6GEYJ331	S.M.CARB 0.1W	5%	330Ω
R122	EVNDXAA03B24	CONTROL 20KΩ		
R123	ERJ6GEYJ104	S.M.CARB 0.1W	5%	100KΩ
R124	ERJ6GEYJ223	S.M.CARB 0.1W	5%	22KΩ
R125	ERJ6GEYJ101	S.M.CARB 0.1W	5%	100Ω
R126	ERJ6GEYJ223	S.M.CARB 0.1W	5%	22KΩ
R127	ERJ6GEYJ473	S.M.CARB 0.1W	5%	47KΩ
R128	ERJ6GEYJ181	S.M.CARB 0.1W	5%	180Ω
R130	ERJ6GEY0R00	S.M.CARB 0.1W	5%	0Ω
R132	ERJ6GEYJ122	S.M.CARB 0.1W	5%	1K2Ω
R133	ERJ6GEYJ122	S.M.CARB 0.1W	5%	1K2Ω
R134	ERJ6GEYJ103	S.M.CARB 0.1W	5%	10KΩ
R135	ERJ6GEYJ103	S.M.CARB 0.1W	5%	10KΩ
R136	ERJ6GEYJ122	S.M.CARB 0.1W	5%	1K2Ω
R137	ERJ6GEYJ104	S.M.CARB 0.1W	5%	100KΩ
R138	ERJ6GEYJ122	S.M.CARB 0.1W	5%	1K2Ω
R139	ERJ6GEYJ154	S.M.CARB 0.1W	5%	150KΩ
R141	ERJ6GEYJ330	S.M.CARB 0.1W	5%	33Ω
R142	ERJ6GEYJ271	S.M.CARB 0.1W	5%	270Ω
R143	ERJ6GEYJ123	S.M.CARB 0.1W	5%	12KΩ
R144	ERJ6GEYJ152	S.M.CARB 0.1W	5%	1K5Ω
R145	ERJ6GEYJ331	S.M.CARB 0.1W	5%	330Ω
R146	ERJ6GEYJ104	S.M.CARB 0.1W	5%	100KΩ
R147	ERJ6GEYJ122	S.M.CARB 0.1W	5%	1K2Ω
R148	ERJ6GEYJ183	S.M.CARB 0.1W	5%	18KΩ
R149	ERJ6GEYJ682	S.M.CARB 0.1W	5%	6K8Ω
R150	ERJ6GEYJ221	S.M.CARB 0.1W	5%	220Ω
R151	ERJ6GEYJ471	S.M.CARB 0.1W	5%	470Ω
R152	ERJ6GEYJ103	S.M.CARB 0.1W	5%	10KΩ
R154	ERJ6GEY0R00	S.M.CARB 0.1W	5%	0Ω
R156	ERJ6GEY0R00	S.M.CARB 0.1W	5%	0Ω
R157	ERJ6GEYJ101	S.M.CARB 0.1W	5%	100Ω
R159	ERJ6GEYJ153	S.M.CARB 0.1W	5%	15KΩ
R251	ERJ6GEYJ2R2	SM.CARB0.125W	5%	2R2Ω
R252	ERJ6GEYJ183	S.M.CARB 0.1W	5%	18KΩ
R253	ERJ6GEYJ103	S.M.CARB 0.1W	5%	10KΩ
R254	ERJ6GEYJ223	S.M.CARB 0.1W	5%	22KΩ
R255	ERJ6GEYJ561	S.M.CARB 0.1W	5%	560Ω
R256	ERJ6GEYJ104	S.M.CARB 0.1W	5%	100KΩ
R257	ERJ6GEYJ102	S.M.CARB 0.1W	5%	1KΩ
R258	ERJ6GEYJ471	S.M.CARB 0.1W	5%	470Ω

Ref No.	Part No.	Description			
R259	ERG3SJS120	METAL 3W	5%	12Ω	▲
R260	ERJ6GEYJ2R2	SM.CARB0.125W	5%	2R2Ω	
R261	ERJ6GEYJ183	S.M.CARB 0.1W	5%	18KΩ	
R262	ERJ6GEYJ223	S.M.CARB 0.1W	5%	22KΩ	
R263	ERJ6GEYJ561	S.M.CARB 0.1W	5%	560Ω	
R264	ERJ6GEYJ104	S.M.CARB 0.1W	5%	100KΩ	
R265	ERJ6GEYJ471	S.M.CARB 0.1W	5%	470Ω	
R266	ERJ6GEYJ102	S.M.CARB 0.1W	5%	1KΩ	
R267	ERJ6GEY0R00	S.M.CARB 0.1W	5%	0Ω	
R268	ERJ6GEY0R00	S.M.CARB 0.1W	5%	0Ω	
R269	ERJ6GEYJ103	S.M.CARB 0.1W	5%	10KΩ	
R270	ERG3SJS120	METAL 3W	5%	12Ω	▲
R350	ERQ12AJ181	FUSABLE 12W	5%	180Ω	▲
R351	ERJ6GEYJ102	S.M.CARB 0.1W	5%	1KΩ	
R352	ERJ6GEYJ102	S.M.CARB 0.1W	5%	1KΩ	
R354	ERJ6GEYJ102	S.M.CARB 0.1W	5%	1KΩ	
R355	ERG2FJ823	METAL 2W	5%	82KΩ	▲
R356	ERJ6GEY0R00	S.M.CARB 0.1W	5%	0Ω	
R357	ERJ6GEYJ822	S.M.CARB 0.1W	5%	8K2Ω	
R358	ERDS1TJ821	CARBON 0.5W	5%	820Ω	
R359	ERJ6GEYJ334	S.M.CARB 0.1W	5%	330KΩ	
R360	ERDS1TJ103	CARBON 0.5W	5%	10KΩ	
R361	ERJ6GEYJ102	S.M.CARB 0.1W	5%	1KΩ	
R362	ERJ6GEYJ102	S.M.CARB 0.1W	5%	1KΩ	
R364	ERJ6GEYJ102	S.M.CARB 0.1W	5%	1KΩ	
R365	ERG2FJ823	METAL 2W	5%	82KΩ	▲
R366	ERJ6GEY0R00	S.M.CARB 0.1W	5%	0Ω	
R367	ERJ6GEYJ822	S.M.CARB 0.1W	5%	8K2Ω	
R368	ERDS1TJ821	CARBON 0.5W	5%	820Ω	
R369	ERJ6GEY0R00	S.M.CARB 0.1W	5%	0Ω	
R370	ERQ1CJP1R3	FUSABLE 1W	5%	1R3Ω	▲
R371	ERJ6GEYJ102	S.M.CARB 0.1W	5%	1KΩ	
R372	ERJ6GEYJ102	S.M.CARB 0.1W	5%	1KΩ	
R374	ERJ6GEYJ102	S.M.CARB 0.1W	5%	1KΩ	
R375	ERG2FJ823	METAL 2W	5%	82KΩ	▲
R376	ERJ6GEY0R00	S.M.CARB 0.1W	5%	0Ω	
R377	ERJ6GEYJ822	S.M.CARB 0.1W	5%	8K2Ω	
R378	ERDS1TJ821	CARBON 0.5W	5%	820Ω	
R379	ERJ6GEY0R00	S.M.CARB 0.1W	5%	0Ω	
R380	ERJ6GEYJ222	S.M.CARB 0.1W	5%	2K2Ω	
R381	ERJ6GEYJ561	S.M.CARB 0.1W	5%	560Ω	
R383	ERJ6GEYJ562	S.M.CARB 0.1W	5%	5K6Ω	
R390	ERDS1TJ184	CARBON 0.5W	5%	180K	
R401	ERJ6GEYJ153	S.M.CARB 0.1W	5%	15KΩ	
R402	ERJ6GEYJ332	S.M.CARB 0.1W	5%	3K3Ω	
R403	ERJ6GEYJ392	S.M.CARB 0.1W	5%	3K9Ω	
R406	ERJ6GEYJ393	S.M.CARB 0.1W	5%	39KΩ	
R407	ERJ6GEYJ101	S.M.CARB 0.1W	5%	100Ω	
R408	ERJ6GEYJ101	S.M.CARB 0.1W	5%	100Ω	
R409	ERJ6GEYJ102	S.M.CARB 0.1W	5%	1KΩ	
R410	ERJ6GEYJ100	S.M.CARB 0.1W	5%	10Ω	
R411	ERJ6GEYJ123	S.M.CARB 0.1W	5%	12KΩ	
R412	ERJ6GEYJ103	S.M.CARB 0.1W	5%	10KΩ	
R451	ERJ6ENF3161	S.M.CARB 0.1W	1%	3K16Ω	
R452	ERJ6GEYJ683	S.M.CARB 0.1W	5%	68KΩ	
R453	ERG2FJ820	METAL 2W	5%	82Ω	▲
R454	ERX12SJR82P	RESISTOR 12W	5%	R82Ω	
R455	ERX12SJ1R0	RESISTOR 12W	5%	1R0Ω	
R456	ERDS1TJ220	CARBON 0.5W	5%	22Ω	
R457	ERDS1TJ223	CARBON 0.5W	5%	22KΩ	
R458	ERG1SJ272	METAL 1W	5%	2.7KΩ	▲
R459	ERJ6GEYJ273	S.M.CARB 0.1W	5%	27KΩ	
R460	ERJ6GEYJ683	S.M.CARB 0.1W	5%	68KΩ	
R461	ERJ6GEYJ184	S.M.CARB 0.1W	5%	180KΩ	
R504	ERD25TJ271	CARBON 0.25W	5%	270Ω	
R505	ERG3FJ330	METAL 3W	5%	33Ω	▲
R506	ERDS1TJ152	CARBON 0.5W	5%	1K5Ω	
R507	ERDS1TJ152	CARBON 0.5W	5%	1K5Ω	
R531	ERD25TJ103	CARBON 0.25W	5%	10KΩ	
R532	ERD25TJ103	CARBON 0.25W	5%	10KΩ	
R533	ERD25TJ683	CARBON 0.25W	5%	68KΩ	
R534	ERD25TJ473	CARBON 0.25W	5%	47KΩ	

Ref No.	Part No.	Description				
R535	ERD25TJ472	CARBON 0.25W	5%	4K7Ω		
R536	ERD25TJ103	CARBON 0.25W	5%	10KΩ		
R539	ERD25TJ103	CARBON 0.25W	5%	10KΩ		
R540	ERD25TJ183	CARBON 0.25W	5%	18KΩ		
R541	ERD25TJ102	CARBON 0.25W	5%	1KΩ		
R542	ERD25TJ103	CARBON 0.25W	5%	10KΩ		
R543	ERD25TJ222	CARBON 0.25W	5%	2K2Ω		
R544	ERD25TJ563	CARBON 0.25W	5%	56KΩ		
R545	ERD25TJ102	CARBON 0.25W	5%	1KΩ		
R546	ERD25TJ103	CARBON 0.25W	5%	10KΩ		
R547	ERD25TJ103	CARBON 0.25W	5%	10KΩ		
R551	ERD25TJ103	CARBON 0.25W	5%	10KΩ		
R552	ERD25TJ473	CARBON 0.25W	5%	47KΩ		
R553	ERD25TJ103	CARBON 0.25W	5%	10KΩ		
R554	ERX3SJSR27H	RESISTOR 3W	5%	R27Ω		
R555	ERO25CKF1742	METAL 25W	1%	17KΩ	Δ	
R556	ERO50PKF2802	METAL 50W	1%	28KΩ	Δ	
R557	ERO25CKF5762	METAL 25W	1%	58KΩ	Δ	
R558	ERO50PKF4532	METAL 50W	1%	45KΩ	Δ	
R559	ERO25CKF1002	METAL 0.25W	1%	10KΩ	Δ	
R560	ERD25TJ222	CARBON 0.25W	5%	2K2Ω		
R561	ERD25TJ333	CARBON 0.25W	5%	33KΩ		
R562	ERD25TJ473	CARBON 0.25W	5%	47KΩ		
R564	ERDS1TJ394	CARBON 0.5W	5%	390KΩ		
R565	ERG2FJ120	METAL 2W	5%	12Ω	Δ	
R566	ERDS1TJ183	CARBON 0.5W	5%	18KΩ		
R567	ERG3FJ223	METAL 3W	5%	22KΩ	Δ	
R568	ERDS1TJ330	CARBON 0.5W	5%	33Ω		
R569	ERDS1TJ120	CARBON 0.5W	5%	12Ω		
R570	ERD25TJ103	CARBON 0.25W	5%	10KΩ		
R571	ERX3FJ2R7H	RESISTOR 3W	5%	2R7Ω		
R572	ERG3FJ821	METAL 3W	5%	820Ω	Δ	
R574	ERG3FJ151	METAL 3W	5%	150Ω	Δ	
R577	ERD25TJ683	CARBON 0.25W	5%	68KΩ		
R578	ERD25TJ153	CARBON 0.25W	5%	15KΩ		
R579	ERD25TJ274	CARBON 0.25W	5%	270KΩ		
R580	ERD25TJ563	CARBON 0.25W	5%	56KΩ		
R581	ERD25TJ104	CARBON 0.25W	5%	100KΩ		
R582	ERD25TJ225	CARBON 0.25W	5%	2M2Ω		
R583	ERD25TJ225	CARBON 0.25W	5%	2M2Ω		
R584	ERD25TJ152	CARBON 0.25W	5%	1K5Ω		
R585	TSF19201	FS LINK			Δ	
R587	ERD25TJ222	CARBON 0.25W	5%	2K2Ω		
R588	ERD25TJ222	CARBON 0.25W	5%	2K2Ω		
R589	ERDS1TJ100	CARBON 0.5W	5%	10Ω		
R591	ERF5ZKR33	WIRE 5W	10%	R33Ω		
R592	ERD25TJ103	CARBON 0.25W	5%	10KΩ		
R593	ERD25TJ153	CARBON 0.25W	5%	15KΩ		
R594	ERD25TJ683	CARBON 0.25W	5%	68KΩ		
R601	ERJ6GEYJ101	S.M.CARB 0.1W	5%	100Ω		
R602	ERJ6GEYJ101	S.M.CARB 0.1W	5%	100Ω		
R603	ERJ6GEYJ102	S.M.CARB 0.1W	5%	1KΩ		
R604	ERJ6GEYJ750	S.M.CARB 0.1W	5%	75Ω		
R605	ERJ6GEYJ750	S.M.CARB 0.1W	5%	75Ω		
R606	ERJ6GEYJ750	S.M.CARB 0.1W	5%	75Ω		
R609	ERJ6GEYJ153	S.M.CARB 0.1W	5%	15KΩ		
R610	ERJ6GEYJ823	S.M.CARB 0.1W	5%	82KΩ		
R612	ERJ6GEYJ392	S.M.CARB 0.1W	5%	3K9Ω		
R613	ERJ6GEYJ392	S.M.CARB 0.1W	5%	3K9Ω		
R615	ERJ6GEYJ823	S.M.CARB 0.1W	5%	82KΩ		
R616	ERJ6GEYJ101	S.M.CARB 0.1W	5%	100Ω		
R617	ERJ6GEYJ101	S.M.CARB 0.1W	5%	100Ω		
R618	ERJ6GEYJ100	S.M.CARB 0.1W	5%	10Ω		
R619	ERJ6GEY0R00	S.M.CARB 0.1W	5%	0Ω		
R620	ERJ6GEY0R00	S.M.CARB 0.1W	5%	0Ω		
R621	ERJ6GEY0R00	S.M.CARB 0.1W	5%	0Ω		
R624	ERJ6GEYJ151	S.M.CARB 0.1W	5%	150Ω		
R625	ERJ6GEYJ393	S.M.CARB 0.1W	5%	39KΩ		
R626	ERJ6GEYJ153	S.M.CARB 0.1W	5%	15KΩ		
R627	ERJ6GEYJ681	S.M.CARB 0.1W	5%	680Ω		
R628	ERJ6GEYJ151	S.M.CARB 0.1W	5%	150Ω		
R629	ERJ6GEY0R00	S.M.CARB 0.1W	5%	0Ω		

Ref No.	Part No.	Description				
R630	ERJ6GEYJ560	S.M.CARB 0.1W	5%	56Ω		
R632	ERJ6GEYJ393	S.M.CARB 0.1W	5%	39KΩ		
R633	ERJ6GEYJ153	S.M.CARB 0.1W	5%	15KΩ		
R634	ERJ6GEYJ681	S.M.CARB 0.1W	5%	680Ω		
R635	ERJ6GEYJ151	S.M.CARB 0.1W	5%	150Ω		
R636	ERJ6GEY0R00	S.M.CARB 0.1W	5%	0Ω		
R637	ERJ6GEYJ331	S.M.CARB 0.1W	5%	330Ω		
R639	EVNDXAA03B32	CONTROL				300Ω
R640	ERJ6GEY0R00	S.M.CARB 0.1W	5%	0Ω		
R643	ERJ6GEYJ101	S.M.CARB 0.1W	5%	100Ω		
R644	ERJ6GEYJ102	S.M.CARB 0.1W	5%	1KΩ		
R645	ERJ6GEYJ271	S.M.CARB 0.1W	5%	270Ω		
R646	ERJ6GEY0R00	S.M.CARB 0.1W	5%	0Ω		
R647	ERJ6GEYJ151	S.M.CARB 0.1W	5%	150Ω		
R648	ERJ6GEYJ150	S.M.CARB 0.1W	5%	15Ω		
R649	ERJ6GEY0R00	S.M.CARB 0.1W	5%	0Ω		
R651	ERJ6GEYJ225	S.M.CARB 0.125W	5%	2.2MΩ		
R652	ERJ6GEYJ103	S.M.CARB 0.1W	5%	10KΩ		
R653	ERJ6GEYJ103	S.M.CARB 0.1W	5%	10KΩ		
R654	ERJ6GEYJ103	S.M.CARB 0.1W	5%	10KΩ		
R655	ERJ6GEYJ243	S.M.CARB 0.125W	5%	24KΩ		
R656	ERJ6GEYJ103	S.M.CARB 0.1W	5%	10KΩ		
R657	ERJ6GEYJ103	S.M.CARB 0.1W	5%	10KΩ		
R658	ERJ6GEYJ103	S.M.CARB 0.1W	5%	10KΩ		
R659	ERJ6GEYJ102	S.M.CARB 0.1W	5%	1KΩ		
R660	ERJ6GEYJ102	S.M.CARB 0.1W	5%	1KΩ		
R661	ERJ6GEYJ102	S.M.CARB 0.1W	5%	1KΩ		
R662	ERJ6GEY0R00	S.M.CARB 0.1W	5%	0Ω		
R663	ERJ6GEY0R00	S.M.CARB 0.1W	5%	0Ω		
R664	ERC14GJ206D	SOLID 14W	5%	20MΩ		
R665	ERC14GJ206D	SOLID 14W	5%	20MΩ		
R711	ERJ6GEYJ334	S.M.CARB 0.1W	5%	330KΩ		
R712	ERJ6GEYJ333	S.M.CARB 0.1W	5%	33KΩ		
R713	ERJ6GEYJ913	S.M.CARB 0.1W	5%	91KΩ		
R714	ERJ6GEYJ682	S.M.CARB 0.1W	5%	6K8Ω		
R715	ERJ6GEYJ222	S.M.CARB 0.1W	5%	2K2Ω		
R716	ERJ6GEY0R00	S.M.CARB 0.1W	5%	0Ω		
R717	ERJ6GEYJ153	S.M.CARB 0.1W	5%	15KΩ		
R718	ERJ6GEYJ472	S.M.CARB 0.1W	5%	4K7Ω		
R719	ERD25TJ472	CARBON 0.25W	5%	4K7Ω		
R720	ERD25TJ823	CARBON 0.25W	5%	82KΩ		
R801	ERC12ZGK105D	DIODE				
R805	232266296706	THERMISTOR				
R806	ERD25TJ101	CARBON 0.25W	5%	100Ω		
R807	ERD25TJ104	CARBON 0.25W	5%	100KΩ		
R809	ERF10ZK4R7	WOUND 10W	5%	4R7Ω	Δ	
R810	ERD25TJ223	CARBON 0.25W	5%	22KΩ		
R811	ERD25TJ391	CARBON 0.25W	5%	390Ω		
R812	ERD25TJ681	CARBON 0.25W	5%	680Ω		
R814	ERD25TJ472	CARBON 0.25W	5%	4K7Ω		
R815	ERD25TJ100	CARBON 0.25W	5%	10Ω		
R816	ERDS1TJ390	CARBON 0.5W	5%	39Ω		
R818	ERD25TJ511	CARBON 0.25W	5%	510Ω		
R820	ERG3FJ223	METAL 3W	5%	22KΩ	Δ	
R821	ERG3FJ223	METAL 3W	5%	22KΩ	Δ	
R822	ERD25TJ391	CARBON 0.25W	5%	390Ω		
R823	ERX1SJR22	RESISTOR 1W	5%	R22Ω		
R824	ERX1SJR22	RESISTOR 1W	5%	R22Ω		
R825	ERX1SJR22	RESISTOR 1W	5%	R22Ω		
R827	ERDS1FJ820	CARBON 0.5W	5%	82Ω		
R828	ERD25TJ103	CARBON 0.25W	5%	10KΩ		
R829	ERD25TJ471	CARBON 0.25W	5%	470Ω		
R830	ERX1SJR22	RESISTOR 1W	5%	R22Ω		
R831	ERD75TAJ825	CARBON 0.75W	5%	8M2Ω	Δ	
R832	ERG3FJ331	METAL 3W	5%	330Ω	Δ	
R835	ERD25TJ220	CARBON 0.25W	5%	22Ω		
R836	ERD25TJ100	CARBON 0.25W	5%	10Ω		
R837	ERD25TJ183	CARBON 0.25W	5%	18KΩ		
R838	ERD25TJ821	CARBON 0.25W	5%	820Ω		
R853	ERO25CKF1002	METAL 0.25W	1%	10KΩ	Δ	
R854	ERDS1TJ153	CARBON 0.5W	5%	15KΩ		
R855	ERD25TJ472	CARBON 0.25W	5%	4K7Ω		

Ref No.	Part No.	Description				
R856	ERD25TJ473	CARBON 0.25W	5%	47KΩ		
R858	ERO25CKF1002	METAL 0.25W	1%	10KΩ	Δ	
R862	ERD25TJ472	CARBON 0.25W	5%	4K7Ω		
R863	ERG3FJ470	METAL 3W	5%	47Ω	Δ	
R864	ERDS1TJ103	CARBON 0.5W	5%	10KΩ		
R865	ERG3FJ470	METAL 3W	5%	47Ω	Δ	
R867	ERD25TJ102	CARBON 0.25W	5%	1KΩ		
R870	ERD25TJ101	CARBON 0.25W	5%	100Ω		
R873	ERDS1TJ3R3	CARBON 0.5W	5%	3R3Ω		
R876	ERD25TJ562	CARBON 0.25W	5%	5K6Ω		
R877	ERO25CKF1022	METAL 25W	1%	10KΩ	Δ	
R878	ERO25CKF1002	METAL 0.25W	1%	10KΩ	Δ	
R883	ERD25TJ103	CARBON 0.25W	5%	10KΩ		
R885	ERD25TJ103	CARBON 0.25W	5%	10KΩ		
R886	ERF20ZK4R7	WIRE 20W	10%	4R7Ω		
R888	ERDS1TJ393	CARBON 0.5W	5%	39KΩ		
R889	ERD25TJ392	CARBON 0.25W	5%	3K9Ω		
R890	ERX3SJR47P	RESISTOR 3W	5%	R47Ω		
R891	ERD25TJ103	CARBON 0.25W	5%	10KΩ		
R892	ERD25TJ222	CARBON 0.25W	5%	2K2Ω		
R894	ERD25TJ101	CARBON 0.25W	5%	100Ω		
R905	ERJ6GEYJ681	S.M.CARB 0.1W	5%	680Ω		
R906	ERJ6GEYJ153	S.M.CARB 0.1W	5%	15KΩ		
R907	ERJ6GEYJ222	S.M.CARB 0.1W	5%	2K2Ω		
R908	ERJ6GEYJ471	S.M.CARB 0.1W	5%	470Ω		
R909	ERJ6GEYJ222	S.M.CARB 0.1W	5%	2K2Ω		
R910	ERJ6GEYJ101	S.M.CARB 0.1W	5%	100Ω		
R911	ERD25TJ561	CARBON 0.25W	5%	560Ω		
R913	ERJ6GEYJ183	S.M.CARB 0.1W	5%	18KΩ		
R914	ERJ6GEYJ242	S.M.CARB 0.1W	5%	2K4Ω		
R915	ERJ6GEYJ182	S.M.CARB 0.1W	5%	1K8Ω		
R916	ERJ6GEYJ221	S.M.CARB 0.1W	5%	220Ω		
R918	ERJ6GEYJ101	S.M.CARB 0.1W	5%	100Ω		
R919	ERQ14AJW390	FUSABLE 14W	5%	39Ω	Δ	
R920	ERQ14AJW390	FUSABLE 14W	5%	39Ω	Δ	
R922	ERD25TJ683	CARBON 0.25W	5%	68KΩ		
R923	ERD25TJ683	CARBON 0.25W	5%	68KΩ		
R924	ERDS1FYJ560	CARBON 0.5W	5%	56Ω		
R925	ERJ6GEY0R00	S.M.CARB 0.1W	5%	0Ω		
R926	ERJ6GEY0R00	S.M.CARB 0.1W	5%	0Ω		
R927	ERD25TJ122	CARBON 0.25W	5%	1K2Ω		
R928	ERD25TJ2R7	CARBON 0.25W	5%	2R7Ω		
R929	ERDS1FYJ471	CARBON 0.5W	5%	470Ω	Δ	
R930	ERD25TJ2R7	CARBON 0.25W	5%	2R7Ω		
R931	ERDS1FYJ390	CARBON 0.5W	5%	39Ω	Δ	
R932	ERDS1FYJ101	CARBON 0.5W	5%	100Ω	Δ	
R933	ERJ6GEYJ472	S.M.CARB 0.1W	5%	4K7Ω		
R934	ERJ6GEYJ222	S.M.CARB 0.1W	5%	2K2Ω		
R935	ERQ14AJW3R9	FUSABLE 14W	5%	3R9Ω	Δ	
R936	ERQ1CJP102	METAL 1W	5%	1KΩ	Δ	
R937	ERQ14AJW100	METAL 0.25W	5%	10Ω	Δ	
R938	ERD25TJ122	CARBON 0.25W	5%	1K2Ω		
R940	ERD25TJ3R3	CARBON 0.25W	5%	3R3Ω		
R941	ERD25TJ3R3	CARBON 0.25W	5%	3R3Ω		
R1054	ERD25TJ101	CARBON 0.25W	5%	100Ω		
R1057	ERD25TJ101	CARBON 0.25W	5%	100Ω		
R1058	ERD25TJ471	CARBON 0.25W	5%	470Ω		
R1059	ERD25TJ103	CARBON 0.25W	5%	10KΩ		
R1061	ERD25TJ103	CARBON 0.25W	5%	10KΩ		
R1062	ERD25TJ222	CARBON 0.25W	5%	2K2Ω		
R1063	ERD25TJ222	CARBON 0.25W	5%	2K2Ω		
R1064	ERD25TJ332	CARBON 0.25W	5%	3K3Ω		
R1065	ERD25TJ512	CARBON 0.25W	5%	5K1Ω		
R1066	ERD25TJ912	CARBON 0.25W	5%	9K1Ω		
R1101	ERJ6GEYJ472	S.M.CARB 0.1W	5%	4K7Ω		
R1102	ERJ6GEYJ472	S.M.CARB 0.1W	5%	4K7Ω		
R1103	ERJ6GEYJ472	S.M.CARB 0.1W	5%	4K7Ω		
R1104	ERJ6GEYJ472	S.M.CARB 0.1W	5%	4K7Ω		
R1105	ERJ6GEYJ472	S.M.CARB 0.1W	5%	4K7Ω		
R1106	ERJ6GEYJ472	S.M.CARB 0.1W	5%	4K7Ω		
R1107	ERJ6GEYJ472	S.M.CARB 0.1W	5%	4K7Ω		

Ref No.	Part No.	Description				
R1108	ERJ6GEYJ472	S.M.CARB 0.1W	5%	4K7Ω		
R1111	ERJ6GEYJ101	S.M.CARB 0.1W	5%	100Ω		
R1112	ERJ6GEYJ101	S.M.CARB 0.1W	5%	100Ω		
R1113	ERJ6GEYJ101	S.M.CARB 0.1W	5%	100Ω		
R1116	ERJ6GEYJ101	S.M.CARB 0.1W	5%	100Ω		
R1117	ERJ6GEYJ101	S.M.CARB 0.1W	5%	100Ω		
R1118	ERJ6GEYJ101	S.M.CARB 0.1W	5%	100Ω		
R1119	ERJ6GEYJ101	S.M.CARB 0.1W	5%	100Ω		
R1120	ERJ6GEYJ101	S.M.CARB 0.1W	5%	100Ω		
R1121	ERJ6GEYJ101	S.M.CARB 0.1W	5%	100Ω		
R1122	ERJ6GEYJ101	S.M.CARB 0.1W	5%	100Ω		
R1123	ERJ6GEYJ472	S.M.CARB 0.1W	5%	4K7Ω		
R1124	ERJ6GEYJ103	S.M.CARB 0.1W	5%	10KΩ		
R1125	ERJ6GEYJ103	S.M.CARB 0.1W	5%	10KΩ		
R1126	ERJ6GEYJ101	S.M.CARB 0.1W	5%	100Ω		
R1127	ERJ6GEYJ101	S.M.CARB 0.1W	5%	100Ω		
R1128	ERJ6GEYJ100	S.M.CARB 0.1W	5%	10Ω		
R1129	ERJ6GEYJ100	S.M.CARB 0.1W	5%	10Ω		
R1133	ERJ6GEYJ103	S.M.CARB 0.1W	5%	10KΩ		
R1134	ERJ6GEYJ103	S.M.CARB 0.1W	5%	10KΩ		
R1135	ERJ6GEY0R00	S.M.CARB 0.1W	5%	0Ω		
R1136	ERJ6GEYJ221	S.M.CARB 0.1W	5%	220Ω		
R1137	ERJ6GEYJ561	S.M.CARB 0.1W	5%	560Ω		
R1138	ERJ6GEYJ103	S.M.CARB 0.1W	5%	10KΩ		
R1140	ERJ6GEYJ101	S.M.CARB 0.1W	5%	100Ω		
R1142	ERJ6GEYJ103	S.M.CARB 0.1W	5%	10KΩ		
R1143	ERJ6GEYJ392	S.M.CARB 0.1W	5%	3K9Ω		
R1144	ERJ6GEYJ102	S.M.CARB 0.1W	5%	1KΩ		
R1145	ERJ6GEYJ472	S.M.CARB 0.1W	5%	4K7Ω		
R1149	ERJ6GEYJ473	S.M.CARB 0.1W	5%	47KΩ		
R1150	ERJ6GEYJ472	S.M.CARB 0.1W	5%	4K7Ω		
R1151	ERJ6GEYJ472	S.M.CARB 0.1W	5%	4K7Ω		
R1152	ERJ6GEYJ472	S.M.CARB 0.1W	5%	4K7Ω		
R1153	ERJ6GEYJ472	S.M.CARB 0.1W	5%	4K7Ω		
R1154	ERJ6GEYJ472	S.M.CARB 0.1W	5%	4K7Ω		
R1156	ERJ6GEYJ182	S.M.CARB 0.1W	5%	1K8Ω		
R1163	ERJ6GEYJ152	S.M.CARB 0.1W	5%	1K5Ω		
R1164	ERJ6GEYJ101	S.M.CARB 0.1W	5%	100Ω		
R1169	ERJ6GEYJ102	S.M.CARB 0.1W	5%	1KΩ		
R1170	ERJ6GEYJ332	S.M.CARB 0.1W	5%	3K3Ω		
R1171	ERJ6GEYJ682	S.M.CARB 0.1W	5%	6K8Ω		
R1172	ERJ6GEYJ561	S.M.CARB 0.1W	5%	560Ω		
R1174	ERDS1TJ561	CARBON 0.5W	5%	560Ω		
R1182	ERJ6GEYJ472	S.M.CARB 0.1W	5%	4K7Ω		
R1183	ERJ6GEYJ472	S.M.CARB 0.1W	5%	4K7Ω		
R1184	ERJ6GEYJ472	S.M.CARB 0.1W	5%	4K7Ω		
R1185	ERJ6GEYJ101	S.M.CARB 0.1W	5%	100Ω		
R1186	ERJ6GEYJ103	S.M.CARB 0.1W	5%	10KΩ		
R1188	ERJ6GEYJ222	S.M.CARB 0.1W	5%	2K2Ω		
R1190	ERJ6GEY0R00	S.M.CARB 0.1W	5%	0Ω		
R1191	ERJ6GEYJ104	S.M.CARB 0.1W	5%	100KΩ		
R1192	ERJ6GEYJ104	S.M.CARB 0.1W	5%	100KΩ		
R1193	ERJ6GEYJ103	S.M.CARB 0.1W	5%	10KΩ		
R1194	ERJ6GEYJ101	S.M.CARB 0.1W	5%	100Ω		
R1301	ERJ6GEYJ102	S.M.CARB 0.1W	5%	1KΩ		
R1302	ERJ6GEYJ392	S.M.CARB 0.1W	5%	3K9Ω		
R1305	ERJ6GEYJ560	S.M.CARB 0.1W	5%	56Ω		
R1306	ERJ6GEYJ101	S.M.CARB 0.1W	5%	100Ω		
R1307	ERJ6GEYJ562	S.M.CARB 0.1W	5%	5K6Ω		
R1308	ERJ6GEYJ105	S.M.CARB 0.1W	5%	1MΩ		
R1313	ERJ6GEY0R00	S.M.CARB 0.1W	5%	0Ω		
R1315	ERJ6GEYJ101	S.M.CARB 0.1W	5%	100Ω		
R1317	ERJ6GEYJ181	S.M.CARB 0.1W	5%	180Ω		
R1318	ERJ6GEYJ181	S.M.CARB 0.1W	5%	180Ω		
R1319	ERJ6GEY0R00	S.M.CARB 0.1W	5%	0Ω		
R1320	ERJ6GEYJ472	S.M.CARB 0.1W	5%	4K7Ω		
R1321	ERJ6GEYJ472	S.M.CARB 0.1W	5%	4K7Ω		
R1322	ERJ6GEYJ103	S.M.CARB 0.1W	5%	10KΩ		
R1323	ERJ6GEYJ103	S.M.CARB 0.1W	5%	10KΩ		
R1324	ERJ6GEYJ472	S.M.CARB 0.1W	5%	4K7Ω		
R1325	ERJ6GEYJ101	S.M.CARB 0.1W	5%	100Ω		

Ref No.	Part No.	Description
R1326	ERJ6GEYJ101	S.M.CARB 0.1W 5% 100Ω
R1327	ERJ6GEYJ470	S.M.CARB 0.1W 5% 47Ω
R1328	ERJ6GEYJ102	S.M.CARB 0.1W 5% 1KΩ
R1329	ERJ6GEY0R00	S.M.CARB 0.1W 5% 0Ω
R1337	ERJ6GEYJ562	S.M.CARB 0.1W 5% 5K6Ω
R1340	ERJ6GEYJ272	S.M.CARB 0.1W 5% 2K7Ω
R1501	ERJ6GEYJ560	S.M.CARB 0.1W 5% 56Ω
R1502	ERJ6GEYJ560	S.M.CARB 0.1W 5% 56Ω
R1504	ERJ6GEYJ121	S.M.CARB 0.1W 5% 120Ω
R1507	ERJ6GEYJ272	S.M.CARB 0.1W 5% 2K7Ω
R1508	ERJ6GEYJ121	S.M.CARB 0.1W 5% 120Ω
R1510	ERJ6GEYJ101	S.M.CARB 0.1W 5% 100Ω
R1511	ERJ6GEYJ272	S.M.CARB 0.1W 5% 2K7Ω
R1513	ERJ6GEYJ272	S.M.CARB 0.1W 5% 2K7Ω
R1515	ERJ6GEYJ102	S.M.CARB 0.1W 5% 1KΩ
R1516	ERJ6GEYJ102	S.M.CARB 0.1W 5% 1KΩ
R1517	ERJ6GEYJ102	S.M.CARB 0.1W 5% 1KΩ
R1518	ERJ6GEYJ101	S.M.CARB 0.1W 5% 100Ω
R1519	ERJ6GEYJ101	S.M.CARB 0.1W 5% 100Ω
R1520	ERJ6GEYJ101	S.M.CARB 0.1W 5% 100Ω
R1523	ERJ6GEYJ101	S.M.CARB 0.1W 5% 100Ω
R1550	ERJ6GEYJ221	S.M.CARB 0.1W 5% 220Ω
R1551	ERJ6GEYJ180	S.M.CARB 0.1W 5% 18Ω
R1552	ERJ6GEYJ560	S.M.CARB 0.1W 5% 56Ω
R1554	ERJ6GEYJ180	S.M.CARB 0.1W 5% 18Ω
R1555	ERJ6GEYJ331	S.M.CARB 0.1W 5% 330Ω
R1560	ERJ6GEYJ101	S.M.CARB 0.1W 5% 100Ω
R1561	ERJ6GEYJ101	S.M.CARB 0.1W 5% 100Ω
R1562	ERJ6GEYJ101	S.M.CARB 0.1W 5% 100Ω
R1563	ERJ6GEYJ180	S.M.CARB 0.1W 5% 18Ω
R1568	ERJ6GEYJ221	S.M.CARB 0.1W 5% 220Ω
R1570	ERJ6GEYJ331	S.M.CARB 0.1W 5% 330Ω
R1572	ERJ6GEYJ561	S.M.CARB 0.1W 5% 560Ω
R1575	ERJ6GEYJ391	S.M.CARB 0.1W 5% 390Ω
R1576	ERJ6GEYJ821	S.M.CARB 0.1W 5% 820Ω
R1577	ERJ6GEYJ750	S.M.CARB 0.1W 5% 75Ω
R1578	ERJ6GEYJ100	S.M.CARB 0.1W 5% 10Ω
R1581	ERJ6GEYJ472	S.M.CARB 0.1W 5% 4K7Ω
R1605	ERJ6GEYJ101	S.M.CARB 0.1W 5% 100Ω
R1606	ERJ6GEYJ101	S.M.CARB 0.1W 5% 100Ω
R1608	ERJ6GEYJ472	S.M.CARB 0.1W 5% 4K7Ω
R1620	ERJ6GEYJ472	S.M.CARB 0.1W 5% 4K7Ω
R1621	ERJ6GEYJ101	S.M.CARB 0.1W 5% 100Ω
R1622	ERJ6GEYJ101	S.M.CARB 0.1W 5% 100Ω
R1624	ERJ6GEY0R00	S.M.CARB 0.1W 5% 0Ω
R1625	ERJ6GEYJ271	S.M.CARB 0.1W 5% 270Ω
R1626	ERJ6GEYJ391	S.M.CARB 0.1W 5% 390Ω
R1627	ERJ6GEYJ622	SM.CARBO.125W 5% 6.2KΩ
R1628	ERJ6GEYJ151	S.M.CARB 0.1W 5% 150Ω
R1629	ERJ6GEYJ201	S.M.CARB 0.1W 5% 200Ω
R1630	ERJ6GEYJ181	S.M.CARB 0.1W 5% 180Ω
R1631	ERJ6GEYJ103	S.M.CARB 0.1W 5% 10KΩ
R1632	ERJ6GEYJ133	SM.CARBO.125W 5% 13KΩ
R1633	ERJ6GEYJ151	S.M.CARB 0.1W 5% 150Ω
R1634	ERJ6GEY0R00	S.M.CARB 0.1W 5% 0Ω
R1641	ERJ6GEYJ560	S.M.CARB 0.1W 5% 56Ω
R1643	ERJ6GEYJ102	S.M.CARB 0.1W 5% 1KΩ
R1644	ERJ6GEYJ560	S.M.CARB 0.1W 5% 56Ω
R1646	ERJ6GEYJ331	S.M.CARB 0.1W 5% 330Ω
R1647	ERJ6GEYJ151	S.M.CARB 0.1W 5% 150Ω
R1648	ERJ6GEYJ560	S.M.CARB 0.1W 5% 56Ω
R1649	ERJ6GEYJ560	S.M.CARB 0.1W 5% 56Ω
R1650	ERJ6GEYJ560	S.M.CARB 0.1W 5% 56Ω
R1652	ERJ6GEYJ102	S.M.CARB 0.1W 5% 1KΩ
R1653	ERJ6GEYJ560	S.M.CARB 0.1W 5% 56Ω
R1654	ERJ6GEYJ560	S.M.CARB 0.1W 5% 56Ω
R1656	ERJ6GEYJ102	S.M.CARB 0.1W 5% 1KΩ
R1659	ERJ6GEYJ560	S.M.CARB 0.1W 5% 56Ω
R1662	ERJ6GEYJ560	S.M.CARB 0.1W 5% 56Ω
R1666	ERJ6GEY0R00	S.M.CARB 0.1W 5% 0Ω
R1667	ERJ6GEYJ560	S.M.CARB 0.1W 5% 56Ω
R1668	ERJ6GEYJ560	S.M.CARB 0.1W 5% 56Ω

Ref No.	Part No.	Description
R1679	ERJ6GEYJ473	S.M.CARB 0.1W 5% 47KΩ
R1680	ERJ6GEYJ153	S.M.CARB 0.1W 5% 15KΩ
R1681	ERJ6GEY0R00	S.M.CARB 0.1W 5% 0Ω
R1682	ERJ6GEYJ151	S.M.CARB 0.1W 5% 150Ω
R1683	ERJ6GEYJ151	S.M.CARB 0.1W 5% 150Ω
R1688	ERJ6GEYJ561	S.M.CARB 0.1W 5% 560Ω
R1701	ERJ6GEYJ180	S.M.CARB 0.1W 5% 18Ω
R1703	ERJ6GEYJ101	S.M.CARB 0.1W 5% 100Ω
R1704	ERJ6GEYJ101	S.M.CARB 0.1W 5% 100Ω
R1705	ERJ6GEYJ473	S.M.CARB 0.1W 5% 47KΩ
R1706	ERJ6GEYJ473	S.M.CARB 0.1W 5% 47KΩ
R1707	ERJ6GEYJ180	S.M.CARB 0.1W 5% 18Ω
R1710	ERJ6GEYJ180	S.M.CARB 0.1W 5% 18Ω
R1713	ERJ6GEYJ472	S.M.CARB 0.1W 5% 4K7Ω
R1716	ERJ6GEY0R00	S.M.CARB 0.1W 5% 0Ω
R1724	ERJ6GEYJ561	S.M.CARB 0.1W 5% 560Ω
R1730	ERJ6GEYJ821	S.M.CARB 0.1W 5% 820Ω
R1777	ERJ6GEYJ561	S.M.CARB 0.1W 5% 560Ω
R1778	ERJ6GEYJ821	S.M.CARB 0.1W 5% 820Ω
R1801	ERJ6GEY0R00	S.M.CARB 0.1W 5% 0Ω
R1802	ERJ6GEY0R00	S.M.CARB 0.1W 5% 0Ω
R1803	ERJ6GEY0R00	S.M.CARB 0.1W 5% 0Ω
R1804	ERJ6GEYJ153	S.M.CARB 0.1W 5% 15KΩ
R1805	ERJ6GEYJ561	S.M.CARB 0.1W 5% 560Ω
R1806	ERJ6GEYJ823	S.M.CARB 0.1W 5% 82KΩ
R1807	ERJ6GEYJ100	S.M.CARB 0.1W 5% 10Ω
R1808	ERJ6GEYJ100	S.M.CARB 0.1W 5% 10Ω
R1809	ERJ6GEYJ391	S.M.CARB 0.1W 5% 390Ω
R1810	ERJ6GEYJ391	S.M.CARB 0.1W 5% 390Ω
R1811	ERJ6GEYJ221	S.M.CARB 0.1W 5% 220Ω
R1814	ERJ6GEY0R00	S.M.CARB 0.1W 5% 0Ω
R1815	ERJ6GEYJ562	S.M.CARB 0.1W 5% 5K6Ω
R1816	ERJ6GEYJ152	S.M.CARB 0.1W 5% 1K5Ω
R1817	ERJ6GEYJ471	S.M.CARB 0.1W 5% 470Ω
R1818	ERJ6GEY0R00	S.M.CARB 0.1W 5% 0Ω
R1819	ERJ6GEY0R00	S.M.CARB 0.1W 5% 0Ω
R1820	ERJ6GEY0R00	S.M.CARB 0.1W 5% 0Ω
R1821	ERQ14AJW221	FUSABLE 14W 5% 220Ω ▲
R1823	ERJ6GEYJ563	S.M.CARB 0.1W 5% 56KΩ
R1833	ERJ6GEYJ101	S.M.CARB 0.1W 5% 100Ω
R1834	ERJ6GEYJ101	S.M.CARB 0.1W 5% 100Ω
R1835	ERJ6GEYJ472	S.M.CARB 0.1W 5% 4K7Ω
R1839	ERJ6GEYJ225	SM.CARBO.125W 5% 2.2MΩ
R1841	ERJ6GEYJ682	S.M.CARB 0.1W 5% 6K8Ω
R1842	ERJ6GEYJ121	S.M.CARB 0.1W 5% 120Ω
R1843	ERJ6GEYJ121	S.M.CARB 0.1W 5% 120Ω
R1844	ERJ6GEYJ121	S.M.CARB 0.1W 5% 120Ω
R1860	ERJ6GEYJ101	S.M.CARB 0.1W 5% 100Ω
R1861	ERJ6GEYJ101	S.M.CARB 0.1W 5% 100Ω
R1862	ERJ6GEYJ391	S.M.CARB 0.1W 5% 390Ω
R1863	ERJ6GEYJ391	S.M.CARB 0.1W 5% 390Ω
R1864	ERJ6GEYJ391	S.M.CARB 0.1W 5% 390Ω
R1866	ERJ6GEYJ471	S.M.CARB 0.1W 5% 470Ω
R1867	ERJ6GEYJ681	S.M.CARB 0.1W 5% 680Ω
R1868	ERJ6GEY0R00	S.M.CARB 0.1W 5% 0Ω
R1873	ERJ6GEY0R00	S.M.CARB 0.1W 5% 0Ω
R1874	ERJ6GEY0R00	S.M.CARB 0.1W 5% 0Ω
R1875	ERJ6GEY0R00	S.M.CARB 0.1W 5% 0Ω
R1877	ERC14GJ206D	SOLID 14W 5% 20MΩ
R1878	ERC14GJ206D	SOLID 14W 5% 20MΩ
R1879	ERJ6GEYJ471	S.M.CARB 0.1W 5% 470Ω
R1880	ERJ6GEYJ471	S.M.CARB 0.1W 5% 470Ω
R1881	ERJ6GEYJ471	S.M.CARB 0.1W 5% 470Ω
R1882	ERJ6GEYJ471	S.M.CARB 0.1W 5% 470Ω
R1883	ERJ6GEYJ471	S.M.CARB 0.1W 5% 470Ω
R1884	ERJ6GEYJ471	S.M.CARB 0.1W 5% 470Ω
R1896	ERJ6GEY0R00	S.M.CARB 0.1W 5% 0Ω
R1897	ERJ6GEY0R00	S.M.CARB 0.1W 5% 0Ω
R1898	ERJ6GEY0R00	S.M.CARB 0.1W 5% 0Ω
R1899	ERJ6GEYJ122	S.M.CARB 0.1W 5% 1K2Ω
R1901	ERG1SJ680	METAL 1W 5% 68Ω ▲

Ref No.	Part No.	Description		
R1903	ERD25TJ154	CARBON 0.25W	5%	150KΩ
R1904	ERD25TJ154	CARBON 0.25W	5%	150KΩ
R1905	ERD25TJ154	CARBON 0.25W	5%	150KΩ
R1906	ERD25TJ753	CARBON 0.25W	5%	75KΩ
R1908	ERD25TJ682	CARBON 0.25W	5%	6K8Ω
R1909	ERD25TJ362	CARBON 0.25W	5%	3.6KΩ
R2001	ERJ6GEYJ473	S.M.CARB 0.1W	5%	47KΩ
R2004	ERJ6GEYJ103	S.M.CARB 0.1W	5%	10KΩ
R2005	ERJ6GEYJ101	S.M.CARB 0.1W	5%	100Ω
R2006	ERJ6GEYJ101	S.M.CARB 0.1W	5%	100Ω
R2007	ERJ6GEYJ183	S.M.CARB 0.1W	5%	18KΩ
R2008	ERJ6GEY0R00	S.M.CARB 0.1W	5%	0Ω
R2009	ERJ6GEY0R00	S.M.CARB 0.1W	5%	0Ω
R2010	ERJ6GEYJ101	S.M.CARB 0.1W	5%	100Ω
R2011	ERJ6GEYJ222	S.M.CARB 0.1W	5%	2K2Ω
R2012	ERJ6GEYJ101	S.M.CARB 0.1W	5%	100Ω
R2013	ERJ6GEYJ222	S.M.CARB 0.1W	5%	2K2Ω
R2014	ERJ6GEYJ471	S.M.CARB 0.1W	5%	470Ω
R2015	ERJ6GEYJ222	S.M.CARB 0.1W	5%	2K2Ω
R2016	ERJ6GEYJ471	S.M.CARB 0.1W	5%	470Ω
R2017	ERJ6GEYJ222	S.M.CARB 0.1W	5%	2K2Ω
R2018	ERJ6GEYJ471	S.M.CARB 0.1W	5%	470Ω
R2019	ERJ6GEYJ471	S.M.CARB 0.1W	5%	470Ω
R2020	ERJ6GEYJ562	S.M.CARB 0.1W	5%	5K6Ω
R2021	ERJ6GEYJ102	S.M.CARB 0.1W	5%	1KΩ
R2022	ERJ6GEYJ471	S.M.CARB 0.1W	5%	470Ω
R2023	ERJ6GEYJ101	S.M.CARB 0.1W	5%	100Ω
R2025	ERJ6GEYJ123	S.M.CARB 0.1W	5%	12KΩ
R2026	ERJ6GEYJ562	S.M.CARB 0.1W	5%	5K6Ω
R2027	ERJ6GEYJ102	S.M.CARB 0.1W	5%	1KΩ
R2038	ERJ6GEY0R00	S.M.CARB 0.1W	5%	0Ω
R2039	ERJ6GEYJ471	S.M.CARB 0.1W	5%	470Ω
R2044	ERJ6GEYJ471	S.M.CARB 0.1W	5%	470Ω
R2045	ERJ6GEYJ471	S.M.CARB 0.1W	5%	470Ω
R2351	ERQ14AJW100	METAL 0.25W	5%	10Ω
R2352	ERD25TJ101	CARBON 0.25W	5%	100Ω
R2353	ERD25TJ101	CARBON 0.25W	5%	100Ω
R2354	ERD25TJ473	CARBON 0.25W	5%	47KΩ
R2355	ERD25TJ102	CARBON 0.25W	5%	1KΩ
R2356	ERD25TJ102	CARBON 0.25W	5%	1KΩ
R2357	ERD25TJ102	CARBON 0.25W	5%	1KΩ
R2358	ERD25TJ102	CARBON 0.25W	5%	1KΩ
R2359	ERD25TJ271	CARBON 0.25W	5%	270Ω
R2360	ERD25TJ183	CARBON 0.25W	5%	18KΩ
R2361	ERD25TJ100	CARBON 0.25W	5%	10Ω
R2371	ERQ14AJW100	METAL 0.25W	5%	10Ω
R2372	ERD25TJ101	CARBON 0.25W	5%	100Ω
R2373	ERD25TJ101	CARBON 0.25W	5%	100Ω
R2374	ERD25TJ473	CARBON 0.25W	5%	47KΩ
R2375	ERD25TJ102	CARBON 0.25W	5%	1KΩ
R2376	ERD25TJ102	CARBON 0.25W	5%	1KΩ
R2377	ERD25TJ102	CARBON 0.25W	5%	1KΩ
R2378	ERD25TJ102	CARBON 0.25W	5%	1KΩ
R2379	ERD25TJ271	CARBON 0.25W	5%	270Ω
R2380	ERD25TJ183	CARBON 0.25W	5%	18KΩ
R2381	ERD25TJ100	CARBON 0.25W	5%	10Ω
R2401	ERJ6GEYJ563	S.M.CARB 0.1W	5%	56KΩ
R2402	ERJ6GEYJ563	S.M.CARB 0.1W	5%	56KΩ
R2403	ERJ6GEYJ104	S.M.CARB 0.1W	5%	100KΩ
R2404	ERJ6GEYJ104	S.M.CARB 0.1W	5%	100KΩ
R2405	ERJ6GEYJ223	S.M.CARB 0.1W	5%	22KΩ
R2406	ERJ6GEYJ821	S.M.CARB 0.1W	5%	820Ω
R2408	ERJ6GEY0R00	S.M.CARB 0.1W	5%	0Ω
R2409	ERJ6GEYJ1R0	S.M.CARB 0.125W	5%	1R0Ω
R2410	ERJ6GEYJ123	S.M.CARB 0.1W	5%	12KΩ
R2411	ERJ6GEYJ272	S.M.CARB 0.1W	5%	2K7Ω
R2412	ERJ6GEYJ223	S.M.CARB 0.1W	5%	22KΩ
R2416	ERJ6GEY0R00	S.M.CARB 0.1W	5%	0Ω
R2417	ERJ6GEY0R00	S.M.CARB 0.1W	5%	0Ω
R2418	ERJ6GEY0R00	S.M.CARB 0.1W	5%	0Ω
R2419	ERJ6GEY0R00	S.M.CARB 0.1W	5%	0Ω
R2420	ERJ6GEY0R00	S.M.CARB 0.1W	5%	0Ω

Ref No.	Part No.	Description		
R2421	ERJ6GEYJ102	S.M.CARB 0.1W	5%	1KΩ
R2422	ERJ6GEYJ102	S.M.CARB 0.1W	5%	1KΩ
R2423	ERJ6GEYJ104	S.M.CARB 0.1W	5%	100KΩ
R2424	ERJ6GEYJ332	S.M.CARB 0.1W	5%	3K3Ω
R2425	ERJ6GEYJ273	S.M.CARB 0.1W	5%	27KΩ
R2426	ERJ6GEYJ104	S.M.CARB 0.1W	5%	100KΩ
R2427	ERJ6GEYJ102	S.M.CARB 0.1W	5%	1KΩ
R2428	ERJ6GEYJ821	S.M.CARB 0.1W	5%	820Ω
R2430	ERJ6GEYJ153	S.M.CARB 0.1W	5%	15KΩ
R2431	ERJ6GEYJ223	S.M.CARB 0.1W	5%	22KΩ
R2434	ERJ6GEYJ103	S.M.CARB 0.1W	5%	10KΩ
R2435	ERJ6GEYJ103	S.M.CARB 0.1W	5%	10KΩ
R2436	ERJ6GEYJ104	S.M.CARB 0.1W	5%	100KΩ
R2437	ERJ6GEYJ471	S.M.CARB 0.1W	5%	470Ω
R2438	ERJ6GEYJ104	S.M.CARB 0.1W	5%	100KΩ
R2439	ERJ6GEYJ471	S.M.CARB 0.1W	5%	470Ω
R2440	ERJ6GEYJ273	S.M.CARB 0.1W	5%	27KΩ
R2441	ERJ6GEYJ104	S.M.CARB 0.1W	5%	100KΩ
R2442	ERJ6GEYJ102	S.M.CARB 0.1W	5%	1KΩ
R2443	ERJ6GEYJ473	S.M.CARB 0.1W	5%	47KΩ
R2444	ERJ6GEYJ101	S.M.CARB 0.1W	5%	100Ω
R2445	ERJ6GEYJ473	S.M.CARB 0.1W	5%	47KΩ
R2446	ERJ6GEYJ101	S.M.CARB 0.1W	5%	100Ω
R2447	ERJ6GEYJ472	S.M.CARB 0.1W	5%	4K7Ω
R2448	ERJ6GEYJ333	S.M.CARB 0.1W	5%	33KΩ
R2449	ERJ6GEYJ103	S.M.CARB 0.1W	5%	10KΩ
R2450	ERJ6GEYJ104	S.M.CARB 0.1W	5%	100KΩ
R2451	ERJ6GEYJ104	S.M.CARB 0.1W	5%	100KΩ
R2452	ERJ6GEYJ472	S.M.CARB 0.1W	5%	4K7Ω
R2453	ERJ6GEYJ224	S.M.CARB 0.1W	5%	220KΩ
R2454	ERJ6GEYJ224	S.M.CARB 0.1W	5%	220KΩ
R2455	ERJ6GEYJ104	S.M.CARB 0.1W	5%	100KΩ
R2456	ERJ6GEYJ821	S.M.CARB 0.1W	5%	820Ω
R2457	ERJ6GEYJ273	S.M.CARB 0.1W	5%	27KΩ
R2458	ERJ6GEYJ104	S.M.CARB 0.1W	5%	100KΩ
R2459	ERJ6GEYJ102	S.M.CARB 0.1W	5%	1KΩ
R2460	ERJ6GEYJ473	S.M.CARB 0.1W	5%	47KΩ
R2461	ERJ6GEYJ101	S.M.CARB 0.1W	5%	100Ω
R2462	ERJ6GEYJ104	S.M.CARB 0.1W	5%	100KΩ
R2463	ERJ6GEYJ104	S.M.CARB 0.1W	5%	100KΩ
R2464	ERJ6GEYJ272	S.M.CARB 0.1W	5%	2K7Ω
R2465	ERJ6GEYJ104	S.M.CARB 0.1W	5%	100KΩ
R2466	ERJ6GEYJ821	S.M.CARB 0.1W	5%	820Ω
R2467	ERJ6GEYJ273	S.M.CARB 0.1W	5%	27KΩ
R2468	ERJ6GEYJ104	S.M.CARB 0.1W	5%	100KΩ
R2469	ERJ6GEYJ102	S.M.CARB 0.1W	5%	1KΩ
R2470	ERJ6GEYJ473	S.M.CARB 0.1W	5%	47KΩ
R2471	ERJ6GEYJ101	S.M.CARB 0.1W	5%	100Ω
R2472	ERJ6GEYJ473	S.M.CARB 0.1W	5%	47KΩ
R2473	ERJ6GEYJ101	S.M.CARB 0.1W	5%	100Ω
R2474	ERJ6GEYJ104	S.M.CARB 0.1W	5%	100KΩ
R2475	ERJ6GEYJ104	S.M.CARB 0.1W	5%	100KΩ
R2476	ERJ6GEYJ471	S.M.CARB 0.1W	5%	470Ω
R2477	ERJ6GEYJ474	S.M.CARB 0.1W	5%	470KΩ
R2478	ERJ6GEYJ272	S.M.CARB 0.1W	5%	2K7Ω
R2479	ERJ6GEYJ104	S.M.CARB 0.1W	5%	100KΩ
R2480	ERJ6GEYJ104	S.M.CARB 0.1W	5%	100KΩ
R2481	ERJ6GEYJ471	S.M.CARB 0.1W	5%	470Ω
R2482	ERJ6GEYJ474	S.M.CARB 0.1W	5%	470KΩ
R2483	ERJ6GEYJ272	S.M.CARB 0.1W	5%	2K7Ω
R2484	ERJ6GEYJ273	S.M.CARB 0.1W	5%	27KΩ
R2485	ERJ6GEYJ104	S.M.CARB 0.1W	5%	100KΩ
R2486	ERJ6GEY0R00	S.M.CARB 0.1W	5%	0Ω
R2487	ERJ6GEYJ103	S.M.CARB 0.1W	5%	10KΩ
R2488	ERJ6GEYJ105	S.M.CARB 0.1W	5%	1MΩ
R2489	ERJ6GEYJ103	S.M.CARB 0.1W	5%	10KΩ
R2490	ERJ6GEYJ472	S.M.CARB 0.1W	5%	4K7Ω
R2491	ERJ6GEYJ153	S.M.CARB 0.1W	5%	15KΩ
R2492	ERJ6GEYJ472	S.M.CARB 0.1W	5%	4K7Ω
R2493	ERJ6GEYJ472	S.M.CARB 0.1W	5%	4K7Ω
R2494	ERJ6GEYJ273	S.M.CARB 0.1W	5%	27KΩ
R2495	ERJ6GEYJ102	S.M.CARB 0.1W	5%	1KΩ

Ref No.	Part No.	Description					
R2496	ERJ6GEYJ102	S.M.CARB	0.1W	5%	1KΩ		
R2497	ERJ6GEYJ472	S.M.CARB	0.1W	5%	4K7Ω		
R2498	ERJ6GEYJ101	S.M.CARB	0.1W	5%	100Ω		
R2499	ERJ6GEYJ101	S.M.CARB	0.1W	5%	100Ω		
R2502	ERDS1TJ154	CARBON	0.5W	5%	150K		
R2503	ERDS1TJ184	CARBON	0.5W	5%	180K		
R2504	ERG5FJ473	METAL	5W	5%	47KΩ	Δ	
R2505	ERG1FJ101P	METAL	1W	5%	100Ω	Δ	
R2506	ERG1FJ101P	METAL	1W	5%	100Ω	Δ	
R2507	ERD2FCVJ4R7P	CARBON	2W	5%	4R7Ω		
R2508	ERW12PKR33	WOUND	0.5W	10%	R33Ω	Δ	
R2509	ERD2FCVJ4R7P	CARBON	2W	5%	4R7Ω		
R2510	TSF19252	FS LINK					Δ
R2511	ERJ6GEY0R00	S.M.CARB	0.1W	5%	0Ω		
R2512	ERJ6GEY0R00	S.M.CARB	0.1W	5%	0Ω		
R2513	TSF19252	FS LINK					Δ
R2514	TSF19632	FS LINK					Δ
R2515	ERG3FJ101	METAL	3W	5%	100Ω	Δ	
R2516	ERG3FJ101	METAL	3W	5%	100Ω	Δ	
R2517	ERDS1TJ2R2	CARBON	0.5W	5%	2.2Ω		
R2518	ERD25TJ101	CARBON	0.25W	5%	100Ω		
R2519	ERD25TJ102	CARBON	0.25W	5%	1KΩ		
R2520	ERDS1TJ103	CARBON	0.5W	5%	10KΩ		
R2521	ERJ6GEYJ223	S.M.CARB	0.1W	5%	22KΩ		
R2522	ERJ6GEYJ821	S.M.CARB	0.1W	5%	820Ω		
R2523	ERG3FJ471	METAL	3W	5%	470Ω	Δ	
R2524	ERG3FJ471	METAL	3W	5%	470Ω	Δ	
R2525	ERJ6GEYJ123	S.M.CARB	0.1W	5%	12KΩ		
R2526	ERJ6GEY0R00	S.M.CARB	0.1W	5%	0Ω		
R2527	ERJ6GEYJ2R2	SM.CARB0.125W		5%	2R2Ω		
R2528	ERJ6GEYJ223	S.M.CARB	0.1W	5%	22KΩ		
R2529	ERJ6GEYJ122	S.M.CARB	0.1W	5%	1K2Ω		
R2530	ERJ6GEYJ123	S.M.CARB	0.1W	5%	12KΩ		
R2531	ERJ6GEY0R00	S.M.CARB	0.1W	5%	0Ω		
R2532	ERJ6GEYJ2R2	SM.CARB0.125W		5%	2R2Ω		
R2534	ERJ6GEYJ104	S.M.CARB	0.1W	5%	100KΩ		
R2535	ERJ6GEYJ101	S.M.CARB	0.1W	5%	100Ω		
R2536	ERJ6GEYJ101	S.M.CARB	0.1W	5%	100Ω		
R2537	ERJ6GEYJ104	S.M.CARB	0.1W	5%	100KΩ		
R2538	ERJ6GEYJ104	S.M.CARB	0.1W	5%	100KΩ		
R2539	ERJ6GEYJ102	S.M.CARB	0.1W	5%	1KΩ		
R2540	ERJ6GEYJ102	S.M.CARB	0.1W	5%	1KΩ		
R2541	ERJ6GEYJ102	S.M.CARB	0.1W	5%	1KΩ		
R2542	ERJ6GEYJ102	S.M.CARB	0.1W	5%	1KΩ		
R2543	ERJ6GEYJ102	S.M.CARB	0.1W	5%	1KΩ		
R2544	ERJ6GEYJ102	S.M.CARB	0.1W	5%	1KΩ		
R2545	ERJ6GEYJ393	S.M.CARB	0.1W	5%	39KΩ		
R2546	ERJ6GEYJ183	S.M.CARB	0.1W	5%	18KΩ		
R2547	ERJ6GEYJ222	S.M.CARB	0.1W	5%	2K2Ω		
R2548	ERJ6GEYJ221	S.M.CARB	0.1W	5%	220Ω		
R2549	ERJ6GEYJ473	S.M.CARB	0.1W	5%	47KΩ		
R2550	ERJ6GEYJ105	S.M.CARB	0.1W	5%	1MΩ		
R2564	ERJ6GEYJ333	S.M.CARB	0.1W	5%	33KΩ		
R2565	ERJ6GEYJ153	S.M.CARB	0.1W	5%	15KΩ		
R2566	ERJ6GEYJ224	S.M.CARB	0.1W	5%	220KΩ		
R2569	ERJ6GEYJ223	S.M.CARB	0.1W	5%	22KΩ		
R2570	ERJ6GEYJ104	S.M.CARB	0.1W	5%	100KΩ		
R2571	ERJ6GEYJ104	S.M.CARB	0.1W	5%	100KΩ		
R2572	ERJ6GEYJ472	S.M.CARB	0.1W	5%	4K7Ω		
R2573	ERJ6GEYJ124	S.M.CARB	0.1W	5%	120KΩ		
R2574	ERJ6GEYJ124	S.M.CARB	0.1W	5%	120KΩ		
R2575	ERJ6GEYJ101	S.M.CARB	0.1W	5%	100Ω		
R2576	ERJ6GEYJ101	S.M.CARB	0.1W	5%	100Ω		
R2577	ERJ6GEYJ183	S.M.CARB	0.1W	5%	18KΩ		
R2578	ERJ6GEYJ104	S.M.CARB	0.1W	5%	100KΩ		
R2579	ERJ6GEYJ104	S.M.CARB	0.1W	5%	100KΩ		
R2580	ERJ6GEYJ104	S.M.CARB	0.1W	5%	100KΩ		
R2581	ERJ6GEYJ104	S.M.CARB	0.1W	5%	100KΩ		
R2582	ERJ6GEYJ104	S.M.CARB	0.1W	5%	100KΩ		
R2583	ERJ6GEYJ102	S.M.CARB	0.1W	5%	1KΩ		
R2584	ERJ6GEYJ104	S.M.CARB	0.1W	5%	100KΩ		
R2585	ERJ6GEYJ102	S.M.CARB	0.1W	5%	1KΩ		

Ref No.	Part No.	Description					
R2586	ERJ6GEYJ561	S.M.CARB	0.1W	5%	560Ω		
R2587	ERJ6GEYJ102	S.M.CARB	0.1W	5%	1KΩ		
R2588	ERJ6GEYJ222	S.M.CARB	0.1W	5%	2K2Ω		
R2589	ERJ6GEYJ392	S.M.CARB	0.1W	5%	3K9Ω		
R2590	ERJ6GEYJ822	S.M.CARB	0.1W	5%	8K2Ω		
R2591	ERJ6GEYJ153	S.M.CARB	0.1W	5%	15KΩ		
R2592	ERJ6GEYJ333	S.M.CARB	0.1W	5%	33KΩ		
R2593	ERJ6GEYJ683	S.M.CARB	0.1W	5%	68KΩ		
R2594	ERJ6GEYJ124	S.M.CARB	0.1W	5%	120KΩ		
R2596	ERJ6GEYJ102	S.M.CARB	0.1W	5%	1KΩ		
R2597	ERJ6GEYJ102	S.M.CARB	0.1W	5%	1KΩ		
R2598	ERJ6GEYJ102	S.M.CARB	0.1W	5%	1KΩ		
R2703	ERJ6GEYJ473	S.M.CARB	0.1W	5%	47KΩ		
R2704	ERJ6GEYJ102	S.M.CARB	0.1W	5%	1KΩ		
R2705	ERJ6GEY0R00	S.M.CARB	0.1W	5%	0Ω		
R2706	ERJ6GEY0R00	S.M.CARB	0.1W	5%	0Ω		
R2707	ERJ6GEYJ391	S.M.CARB	0.1W	5%	390Ω		
R2708	ERJ6GEYJ103	S.M.CARB	0.1W	5%	10KΩ		
R2709	ERJ6GEYJ103	S.M.CARB	0.1W	5%	10KΩ		
R2710	ERJ6GEYJ103	S.M.CARB	0.1W	5%	10KΩ		
R2711	ERJ6GEYJ103	S.M.CARB	0.1W	5%	10KΩ		
R2712	ERJ6GEYJ622	SM.CARB0.125W		5%	6.2KΩ		
R2713	ERJ6GEYJ622	SM.CARB0.125W		5%	6.2KΩ		
R2714	ERJ6GEYJ103	S.M.CARB	0.1W	5%	10KΩ		
R2715	ERJ6GEYJ103	S.M.CARB	0.1W	5%	10KΩ		
R2716	ERJ6GEYJ103	S.M.CARB	0.1W	5%	10KΩ		
R2717	ERJ6GEYJ622	SM.CARB0.125W		5%	6.2KΩ		
R2718	ERJ6GEYJ103	S.M.CARB	0.1W	5%	10KΩ		
R2719	ERD25TJ273	CARBON	0.25W	5%	27KΩ		
R2720	ERD25TJ103	CARBON	0.25W	5%	10KΩ		
R2721	ERD25TJ153	CARBON	0.25W	5%	15KΩ		
R2722	EVMEASA00B53	CONTROL			5KΩ		
R2723	ERD25TJ682	CARBON	0.25W	5%	6K8Ω		
R2724	EVMEASA00B53	CONTROL			5KΩ		
R2725	ERO25CKF1272	METAL	25W	1%	13KΩ	Δ	
R2726	ERO25CKF3242	METAL	25W	1%	32KΩ	Δ	
R2727	ERD25TJ103	CARBON	0.25W	5%	10KΩ		
R2728	ERDS1FJ103	CARBON	0.5W	5%	10KΩ		
R2729	ERD25TJ472	CARBON	0.25W	5%	4K7Ω		
R2730	ERDS1FJ103	CARBON	0.5W	5%	10KΩ		
R2731	ERD25TJ561	CARBON	0.25W	5%	560Ω		
R2732	ERD25TJ103	CARBON	0.25W	5%	10KΩ		
R2733	ERD25TJ103	CARBON	0.25W	5%	10KΩ		
R2734	ERD25TJ564	CARBON	0.25W	5%	560KΩ		
R2735	ERDS1FYJ561P	CARBON	0.5W	5%	560Ω		
R2736	ERD25TJ820	CARBON	0.25W	5%	82Ω		
R2738	EVMEASA00B53	CONTROL			5KΩ		
R2739	ERD25TJ472	CARBON	0.25W	5%	4K7Ω		
R2741	ERD25TJ101	CARBON	0.25W	5%	100Ω		
R2742	ERDS1FYJ123P	CARBON	0.5W	5%	12KΩ		
R2743	ERC12GK104V	DIODE					
R2744	ERD25TJ125	CARBON	0.25W	5%	1M2Ω		
R2745	ERD25TJ125	CARBON	0.25W	5%	1M2Ω		
R2746	ERD25TJ104	CARBON	0.25W	5%	100KΩ		
R2747	ERG2SJ123P	METAL	2W	5%	12KΩ	Δ	
R2748	ERD25TJ103	CARBON	0.25W	5%	10KΩ		
R2749	ERDS1FYJ332P	CARBON	0.5W	5%	3.3KΩ		
R2750	ERQ3CJ102H	FUSABLE	3W	5%	1.0KΩ	Δ	
R2751	ERD25TJ334	CARBON	0.25W	5%	330KΩ		
R2752	ERD25TJ101	CARBON	0.25W	5%	100Ω		
R2753	ERG2SJ561	CAPACITOR			560pF		
R2754	ERD25TJ473	CARBON	0.25W	5%	47KΩ		
R2755	ERD25TJ103	CARBON	0.25W	5%	10KΩ		
R2756	ERD25TJ104	CARBON	0.25W	5%	100KΩ		
R2757	ERD25TJ104	CARBON	0.25W	5%	100KΩ		
R2758	ERD25TJ104	CARBON	0.25W	5%	100KΩ		
R2759	ERD25TJ104	CARBON	0.25W	5%	100KΩ		
R2760	ERD25TJ622	CARBON	0.25W	5%	6K2Ω		
R2761	ERD25TJ103	CARBON	0.25W	5%	10KΩ		
R2762	ERD25TJ103	CARBON	0.25W	5%	10KΩ		
R2763	ERD25TJ103	CARBON	0.25W	5%	10KΩ		
R2764	ERD25TJ103	CARBON	0.25W	5%	10KΩ		

Ref No.	Part No.	Description				
R2767	ERD25TJ103	CARBON 0.25W	5%	10KΩ		
R2770	ERD25TJ123	CARBON 0.25W	5%	12KΩ		
R2772	ERQ1CJP471	FUSABLE 1W	5%	470Ω	Δ	
R2773	ERD25TJ102	CARBON 0.25W	5%	1KΩ		
R2774	ERD25TJ102	CARBON 0.25W	5%	1KΩ		
R2775	ERD25TJ102	CARBON 0.25W	5%	1KΩ		
R2776	ERD25TJ102	CARBON 0.25W	5%	1KΩ		
R2777	ERD25TJ472	CARBON 0.25W	5%	4K7Ω		
R2779	ERG1SJ331	METAL 1W	5%	330Ω	Δ	
R2780	ERD25TJ153	CARBON 0.25W	5%	15KΩ		
R2781	ERQ14AJW220	FUSABLE 14W	5%	22Ω	Δ	
R2782	ERD25TJ333	CARBON 0.25W	5%	33KΩ		
R2783	ERD25TJ823	CARBON 0.25W	5%	82KΩ		
R2784	ERD25TJ123	CARBON 0.25W	5%	12KΩ		
R2785	ERDS1FYJ102P	CARBON 0.5W	5%	1.0KΩ		
R2786	ERD25TJ103	CARBON 0.25W	5%	10KΩ		
R2787	ERD25TJ332	CARBON 0.25W	5%	3K3Ω		
R2788	ERD25TJ684	CARBON 0.25W	5%	680KΩ		
R2789	ERD25TJ221	CARBON 0.25W	5%	220Ω		
R2790	ERD25TJ562	CARBON 0.25W	5%	5K6Ω		
R2791	ERD25TJ123	CARBON 0.25W	5%	12KΩ		
R2794	ERD25TJ683	CARBON 0.25W	5%	68KΩ		
R2795	ERD25TJ103	CARBON 0.25W	5%	10KΩ		
R2796	ERD25TJ392	CARBON 0.25W	5%	3K9Ω		
R2797	ERD25TJ183	CARBON 0.25W	5%	18KΩ		
R2798	ERD25TJ103	CARBON 0.25W	5%	10KΩ		
R2801	ERJ6GEYJ473	S.M.CARB 0.1W	5%	47KΩ		
R2802	ERJ6GEYJ103	S.M.CARB 0.1W	5%	10KΩ		
R2803	ERJ6GEYJ103	S.M.CARB 0.1W	5%	10KΩ		
R2804	ERJ6GEYJ104	S.M.CARB 0.1W	5%	100KΩ		
R2805	ERJ6GEYJ563	S.M.CARB 0.1W	5%	56KΩ		
R2806	ERJ6GEYJ154	S.M.CARB 0.1W	5%	150KΩ		
R2807	ERJ6GEYJ474	S.M.CARB 0.1W	5%	470KΩ		
R2808	ERJ6GEYJ393	S.M.CARB 0.1W	5%	39KΩ		
R2809	ERJ6GEYJ184	S.M.CARB 0.1W	5%	180KΩ		
R2810	ERJ6GEYJ184	S.M.CARB 0.1W	5%	180KΩ		
R2811	ERJ6GEYJ393	S.M.CARB 0.1W	5%	39KΩ		
R2812	ERJ6GEYJ474	S.M.CARB 0.1W	5%	470KΩ		
R2813	ERJ6GEYJ104	S.M.CARB 0.1W	5%	100KΩ		
R2814	ERJ6GEYJ184	S.M.CARB 0.1W	5%	180KΩ		
R2815	ERJ6GEYJ333	S.M.CARB 0.1W	5%	33KΩ		
R2816	ERJ6GEYJ102	S.M.CARB 0.1W	5%	1KΩ		
R2817	ERJ6GEYJ473	S.M.CARB 0.1W	5%	47KΩ		
R2818	ERJ6GEYJ102	S.M.CARB 0.1W	5%	1KΩ		
R2819	ERJ6GEYJ473	S.M.CARB 0.1W	5%	47KΩ		
R2820	ERJ6GEYJ102	S.M.CARB 0.1W	5%	1KΩ		
R2821	ERJ6GEYJ473	S.M.CARB 0.1W	5%	47KΩ		
R2822	ERJ6GEYJ102	S.M.CARB 0.1W	5%	1KΩ		
R2823	ERJ6GEYJ473	S.M.CARB 0.1W	5%	47KΩ		
R3006	ERJ6GEYJ750	S.M.CARB 0.1W	5%	75Ω		
R3111	ERJ6GEYJ102	S.M.CARB 0.1W	5%	1KΩ		
R3112	ERJ6GEYJ102	S.M.CARB 0.1W	5%	1KΩ		
R3114	ERJ6GEYJ681	S.M.CARB 0.1W	5%	680Ω		
R3115	ERJ6GEYJ104	S.M.CARB 0.1W	5%	100KΩ		
R3117	ERJ6GEYJ104	S.M.CARB 0.1W	5%	100KΩ		
R3118	ERJ6GEYJ681	S.M.CARB 0.1W	5%	680Ω		
R3119	ERJ6GEYJ333	S.M.CARB 0.1W	5%	33KΩ		
R3120	ERJ6GEYJ101	S.M.CARB 0.1W	5%	100Ω		
R3121	ERJ6GEYJ101	S.M.CARB 0.1W	5%	100Ω		
R3122	ERJ6GEYJ333	S.M.CARB 0.1W	5%	33KΩ		
R3123	ERJ6GEYJ153	S.M.CARB 0.1W	5%	15KΩ		
R3124	ERJ6GEYJ750	S.M.CARB 0.1W	5%	75Ω		
R3125	ERJ6GEYJ470	S.M.CARB 0.1W	5%	47Ω		
R3126	ERJ6GEYJ102	S.M.CARB 0.1W	5%	1KΩ		
R3127	ERJ6GEYJ102	S.M.CARB 0.1W	5%	1KΩ		
R3128	ERJ6GEYJ104	S.M.CARB 0.1W	5%	100KΩ		
R3129	ERJ6GEYJ104	S.M.CARB 0.1W	5%	100KΩ		
R3130	ERJ6GEYJ681	S.M.CARB 0.1W	5%	680Ω		
R3131	ERJ6GEYJ681	S.M.CARB 0.1W	5%	680Ω		
R3132	ERD2FCVG100T	CARBON 2W	2%	10Ω		
R3133	ERJ6GEYJ101	S.M.CARB 0.1W	5%	100Ω		
R3134	ERJ6GEYJ101	S.M.CARB 0.1W	5%	100Ω		

Ref No.	Part No.	Description				
R3135	ERJ6GEYJ101	S.M.CARB 0.1W	5%	100Ω		
R3136	ERJ6GEYJ101	S.M.CARB 0.1W	5%	100Ω		
R3137	ERJ6GEYJ750	S.M.CARB 0.1W	5%	75Ω		
R3138	ERJ6GEYJ470	S.M.CARB 0.1W	5%	47Ω		
R3139	ERJ6GEYJ101	S.M.CARB 0.1W	5%	100Ω		
R3140	ERJ6GEYJ101	S.M.CARB 0.1W	5%	100Ω		
R3141	ERJ6GEYJ101	S.M.CARB 0.1W	5%	100Ω		
R3142	ERJ6GEYJ101	S.M.CARB 0.1W	5%	100Ω		
R3143	ERJ6GEYJ333	S.M.CARB 0.1W	5%	33KΩ		
R3144	ERJ6GEYJ101	S.M.CARB 0.1W	5%	100Ω		
R3145	ERJ6GEYJ101	S.M.CARB 0.1W	5%	100Ω		
R3146	ERJ6GEYJ333	S.M.CARB 0.1W	5%	33KΩ		
R3147	ERJ6GEYJ153	S.M.CARB 0.1W	5%	15KΩ		
R3148	ERJ6GEYJ750	S.M.CARB 0.1W	5%	75Ω		
R3149	ERJ6GEYJ750	S.M.CARB 0.1W	5%	75Ω		
R3150	ERJ6GEYJ470	S.M.CARB 0.1W	5%	47Ω		
R3151	ERJ6GEYJ750	S.M.CARB 0.1W	5%	75Ω		
R3152	ERJ6GEYJ101	S.M.CARB 0.1W	5%	100Ω		
R3153	ERJ6GEYJ101	S.M.CARB 0.1W	5%	100Ω		
R3154	ERD2FCVG100T	CARBON 2W	2%	10Ω		
R3156	ERJ6GEYJ471	S.M.CARB 0.1W	5%	470Ω		
R3157	ERJ6GEYJ221	S.M.CARB 0.1W	5%	220Ω		
R3158	ERJ6GEYJ470	S.M.CARB 0.1W	5%	47Ω		
R3159	ERJ6GEYJ681	S.M.CARB 0.1W	5%	680Ω		
R3160	ERJ6GEYJ563	S.M.CARB 0.1W	5%	56KΩ		
R3161	ERJ6GEYJ121	S.M.CARB 0.1W	5%	120Ω		
R3162	ERJ6GEYJ101	S.M.CARB 0.1W	5%	100Ω		
R3163	ERJ6GEYJ153	S.M.CARB 0.1W	5%	15KΩ		
R3164	ERJ6GEYJ182	S.M.CARB 0.1W	5%	1K8Ω		
R3165	ERJ6GEYJ103	S.M.CARB 0.1W	5%	10KΩ		
R3166	ERJ6GEYJ822	S.M.CARB 0.1W	5%	8K2Ω		
R3167	ERJ6GEYJ103	S.M.CARB 0.1W	5%	10KΩ		
R3168	ERD2FCVG100T	CARBON 2W	2%	10Ω		
R3169	ERJ6GEYOR00	S.M.CARB 0.1W	5%	0Ω		
R3170	ERJ6GEYJ222	S.M.CARB 0.1W	5%	2K2Ω		
R3171	ERJ6GEYJ123	S.M.CARB 0.1W	5%	12KΩ		
R3172	ERJ6GEYJ152	S.M.CARB 0.1W	5%	1K5Ω		
R3173	ERJ6GEYJ561	S.M.CARB 0.1W	5%	560Ω		
R3174	ERJ6GEYJ152	S.M.CARB 0.1W	5%	1K5Ω		
R3175	ERJ6GEYJ562	S.M.CARB 0.1W	5%	5K6Ω		
R3178	ERJ6GEYOR00	S.M.CARB 0.1W	5%	0Ω		
R3180	ERJ6GEYOR00	S.M.CARB 0.1W	5%	0Ω		
R3182	ERJ6GEYOR00	S.M.CARB 0.1W	5%	0Ω		
R3184	ERJ6GEYOR00	S.M.CARB 0.1W	5%	0Ω		
R3185	ERJ6GEYJ333	S.M.CARB 0.1W	5%	33KΩ		
R3186	ERJ6GEYJ101	S.M.CARB 0.1W	5%	100Ω		
R3187	ERJ6GEYJ333	S.M.CARB 0.1W	5%	33KΩ		
R3188	ERJ6GEYJ101	S.M.CARB 0.1W	5%	100Ω		
R3192	ERJ6GEYOR00	S.M.CARB 0.1W	5%	0Ω		
R3193	ERJ6GEYOR00	S.M.CARB 0.1W	5%	0Ω		
R3194	ERJ6GEYJ750	S.M.CARB 0.1W	5%	75Ω		
R3195	ERJ6GEYJ750	S.M.CARB 0.1W	5%	75Ω		
R3196	ERJ6GEYJ470	S.M.CARB 0.1W	5%	47Ω		
R3197	ERD2FCVG100T	CARBON 2W	2%	10Ω		
R3198	ERJ6GEYJ470	S.M.CARB 0.1W	5%	47Ω		
R3199	ERJ6GEYJ470	S.M.CARB 0.1W	5%	47Ω		
R3200	ERJ6GEYJ104	S.M.CARB 0.1W	5%	100KΩ		
R3201	ERJ6GEYJ332	S.M.CARB 0.1W	5%	3K3Ω		
R3202	ERJ6GEYJ332	S.M.CARB 0.1W	5%	3K3Ω		
R3205	ERJ6GEYJ104	S.M.CARB 0.1W	5%	100KΩ		
R3206	ERJ6GEYJ104	S.M.CARB 0.1W	5%	100KΩ		
R3207	ERJ6GEYJ104	S.M.CARB 0.1W	5%	100KΩ		
R3208	ERJ6GEYJ101	S.M.CARB 0.1W	5%	100Ω		
R3209	ERJ6GEYJ101	S.M.CARB 0.1W	5%	100Ω		
R3210	ERJ6GEYJ152	S.M.CARB 0.1W	5%	1K5Ω		
R3211	ERJ6GEYJ152	S.M.CARB 0.1W	5%	1K5Ω		
R3212	ERJ6GEYJ123	S.M.CARB 0.1W	5%	12KΩ		
R3213	ERJ6GEYJ101	S.M.CARB 0.1W	5%	100Ω		
R3214	ERJ6GEYJ153	S.M.CARB 0.1W	5%	15KΩ		
R3215	ERD2FCVG100T	CARBON 2W	2%	10Ω		
R3216	ERJ6GEYJ680	S.M.CARB 0.1W	5%	68Ω		
R3217	ERJ6GEYJ102	S.M.CARB 0.1W	5%	1KΩ		

Ref No.	Part No.	Description			
R3218	ERJ6GEYJ750	S.M.CARB 0.1W	5%	75Ω	
R3219	ERJ6GEYJ123	S.M.CARB 0.1W	5%	12KΩ	
R3220	ERJ6GEYJ101	S.M.CARB 0.1W	5%	100Ω	
R3221	ERJ6GEYJ153	S.M.CARB 0.1W	5%	15KΩ	
R3222	ERJ6GEYJ680	S.M.CARB 0.1W	5%	68Ω	
R3223	ERJ6GEYJ102	S.M.CARB 0.1W	5%	1KΩ	
R3224	ERJ6GEYJ750	S.M.CARB 0.1W	5%	75Ω	
R3225	ERD2FCVG100T	CARBON 2W	2%	10Ω	
R3226	ERJ6GEYJ153	S.M.CARB 0.1W	5%	15KΩ	
R3227	ERJ6GEY0R00	S.M.CARB 0.1W	5%	0Ω	
R3228	ERJ6GEYJ680	S.M.CARB 0.1W	5%	68Ω	
R3229	ERJ6GEYJ101	S.M.CARB 0.1W	5%	100Ω	
R3230	ERJ6GEYJ102	S.M.CARB 0.1W	5%	1KΩ	
R3231	ERD2FCVG100T	CARBON 2W	2%	10Ω	
R3232	ERJ6GEYJ272	S.M.CARB 0.1W	5%	2K7Ω	
R3233	ERJ6GEYJ331	S.M.CARB 0.1W	5%	330Ω	
R3236	ERJ6GEYJ103	S.M.CARB 0.1W	5%	10KΩ	
R3237	ERJ6GEYJ103	S.M.CARB 0.1W	5%	10KΩ	
R3238	ERJ6GEYJ153	S.M.CARB 0.1W	5%	15KΩ	
R3239	ERJ6GEYJ153	S.M.CARB 0.1W	5%	15KΩ	
R3240	ERJ6GEYJ104	S.M.CARB 0.1W	5%	100KΩ	
R3351	ERJ6GEYJ101	S.M.CARB 0.1W	5%	100Ω	
R3352	ERJ6GEYJ472	S.M.CARB 0.1W	5%	4K7Ω	
R3353	ERJ6GEYJ474	S.M.CARB 0.1W	5%	470KΩ	
R3354	ERJ6GEYJ102	S.M.CARB 0.1W	5%	1KΩ	
R3355	ERJ6GEYJ391	S.M.CARB 0.1W	5%	390Ω	
R3501	ERJ6GEYJ100	S.M.CARB 0.1W	5%	10Ω	
R3502	ERJ6GEY0R00	S.M.CARB 0.1W	5%	0Ω	
R3503	ERJ6GEYJ471	S.M.CARB 0.1W	5%	470Ω	
R3505	ERJ6GEYJ100	S.M.CARB 0.1W	5%	10Ω	
R3506	ERJ6GEYJ100	S.M.CARB 0.1W	5%	10Ω	
R3507	ERJ6GEYJ472	S.M.CARB 0.1W	5%	4K7Ω	
R3508	ERJ6GEYJ151	S.M.CARB 0.1W	5%	150Ω	
R3509	ERJ6GEYJ102	S.M.CARB 0.1W	5%	1KΩ	
R3513	ERJ6GEYJ471	S.M.CARB 0.1W	5%	470Ω	
R3514	ERJ6GEYJ471	S.M.CARB 0.1W	5%	470Ω	
R3515	ERJ6GEYJ471	S.M.CARB 0.1W	5%	470Ω	
R3516	ERJ6GEYJ472	S.M.CARB 0.1W	5%	4K7Ω	
R3517	ERJ6GEYJ102	S.M.CARB 0.1W	5%	1KΩ	
R3518	ERJ6GEY0R00	S.M.CARB 0.1W	5%	0Ω	
R3520	ERJ6GEYJ221	S.M.CARB 0.1W	5%	220Ω	
R3521	ERJ6GEY0R00	S.M.CARB 0.1W	5%	0Ω	
R3522	ERJ6GEY0R00	S.M.CARB 0.1W	5%	0Ω	
R3523	ERJ6GEY0R00	S.M.CARB 0.1W	5%	0Ω	
R3526	ERD25TC0T	CARBON 0.25W	5%	0Ω	
R3531	ERJ6GEYJ221	S.M.CARB 0.1W	5%	220Ω	
R3532	ERJ6GEYJ391	S.M.CARB 0.1W	5%	390Ω	
R3534	ERD25TJ181	CARBON 0.25W	5%	180Ω	
R3536	ERJ6GEY0R00	S.M.CARB 0.1W	5%	0Ω	

Ref No.	Part No.	Description			
R3539	ERJ6GEY0R00	S.M.CARB 0.1W	5%	0Ω	
R3540	ERJ6GEYJ392	S.M.CARB 0.1W	5%	3K9Ω	
R3541	ERJ6GEYJ392	S.M.CARB 0.1W	5%	3K9Ω	
R3542	ERJ6GEYJ392	S.M.CARB 0.1W	5%	3K9Ω	
R3802	ERG3FJ100	METAL 3W	5%	10Ω	▲
R3803	ERJ6GEYJ221	S.M.CARB 0.1W	5%	220Ω	
R3804	ERJ6GEYJ101	S.M.CARB 0.1W	5%	100Ω	

SWITCHES

S801	ESB91232A	SWITCH			▲
S1051	EVQPB105K	SWITCH			
S1052	EVQPB105K	SWITCH			
S1053	EVQPB105K	SWITCH			
S1054	EVQPB105K	SWITCH			
S1055	EVQPB105K	SWITCH			

TRANSFORMERS

T501	TLHA003	TRANSFORMER			
T551	ZTFH97039A	F.B.T.			
T801	ETP35KAN615U	TRANSFORMER			
T802	ETS49AH1E7AD	TRANSFORMER			
T803	ETQ24K37AY	LINE FILTER			
T2502	ETS35AA3J7AC	TRANSFORMER			
T2701	ETF18L35A	TRANSFORMER			

FILTERS







X101	EFCT6504BF	FILTER			
X102	EFCT5M7MW3	FILTER			
X103	EFCT6R0MW5	FILTER			
X104	K3953—M100	SAW FILTER			
X105	K9456M	SAW FILTER			
X106	EFCV3195T6	CERAMIC FILTER			
X107	EFCV7004BF	CERAMIC FILTER			
X109	EFCV4045T4	CERAMIC FILTER			
X601	TSSA024	CRYSTAL			
X602	TSSA025	CRYSTAL			
X1101	TAF10020	CRYSTAL			
X1551	TSSA009	CRYSTAL			
X1815	TSSA024	CRYSTAL			
X1816	TSSA025	CRYSTAL			
X1841	TSSA009	CRYSTAL			
X2001	4730007158	CRYSTAL			
X2501	TAF10059	CRYSTAL			
X2502	TAFCSA4.00MG	CRYSTAL			
X3501	TSSA009	CRYSTAL			

SCHEMA ELETTRICO TX-W36D3DP (TELAIO EURO-3HWS)

IMPORTANTE

I componenti indicati con  hanno caratteristiche speciali ed importante per la sicurezza. Qualora tali componenti vengano sostituiti, devono essere usati solo quelli specificati dal costruttore.

Nota

1. **RESISTENZE**
Tutte le resistenze sono al carbone da 1/8W se sono contrassegnate come segue:
I valori sono espressi in OHM Ω K=1,000 M=1,000,000.
2. **CONDENSATORI**
Tutti i condensatori sono ceramici 50V, se non sono contrassegnati come segue:
I valori sono espressi in μ F, se non diversamente specificato.
3. **BOBINE**
I valori sono espressi in μ H, se non diversamente specificato.
Il contrassegno "L" sullo schema elettrico indica la polarità.
4. **TEST POINT**
 Posizione dei Test point
5. **MASSA**
 Massa Telaio (Freddo)
 Massa Linea (Caldo)
6. **CONTROLLI DI TENSIONE**
Le tensioni sono misurate con voltmetro DC alle seguenti condizioni:
Tensione di rete AC 220 – 240V nominale 50Hz
Segnale campione segnale barre colore (RF)
Comandi esterni al massimo
7. Indica il flusso di segnale principale
 Video
 Audio
 Verticale/orizzontale
8. Questo schema elettrico è soggetto a variazioni senza preavviso.

Precauzioni

- a. Nell'intento di prevenire possibili scosse elettriche evitare contemporaneamente le sezioni definite calde e fredde.
- b. Un corto circuito fra le due sezioni può provocare anomalie nei componenti.
- c. Nell'utilizzo di uno strumento di misura la massa dello stesso deve essere collegata alla massa del circuito da misurare.
- d. Le resistenze sotto indicate sono componenti fusibili di sicurezza, e risultano differenziati per valore di corrente.

Nota :

9. Nel circuito di alimentazione è presente una sezione le cui tensioni risultano separate dalla massa generale del telaio. Sullo schema elettrico vengono definite aree calda e fredda. Prestare particolare attenzione. Tutti i circuiti escluso quella di alimentazione sono freddi.

SCHEMA - B

MEDIA FREQUENZA VIDEO/AUDIO

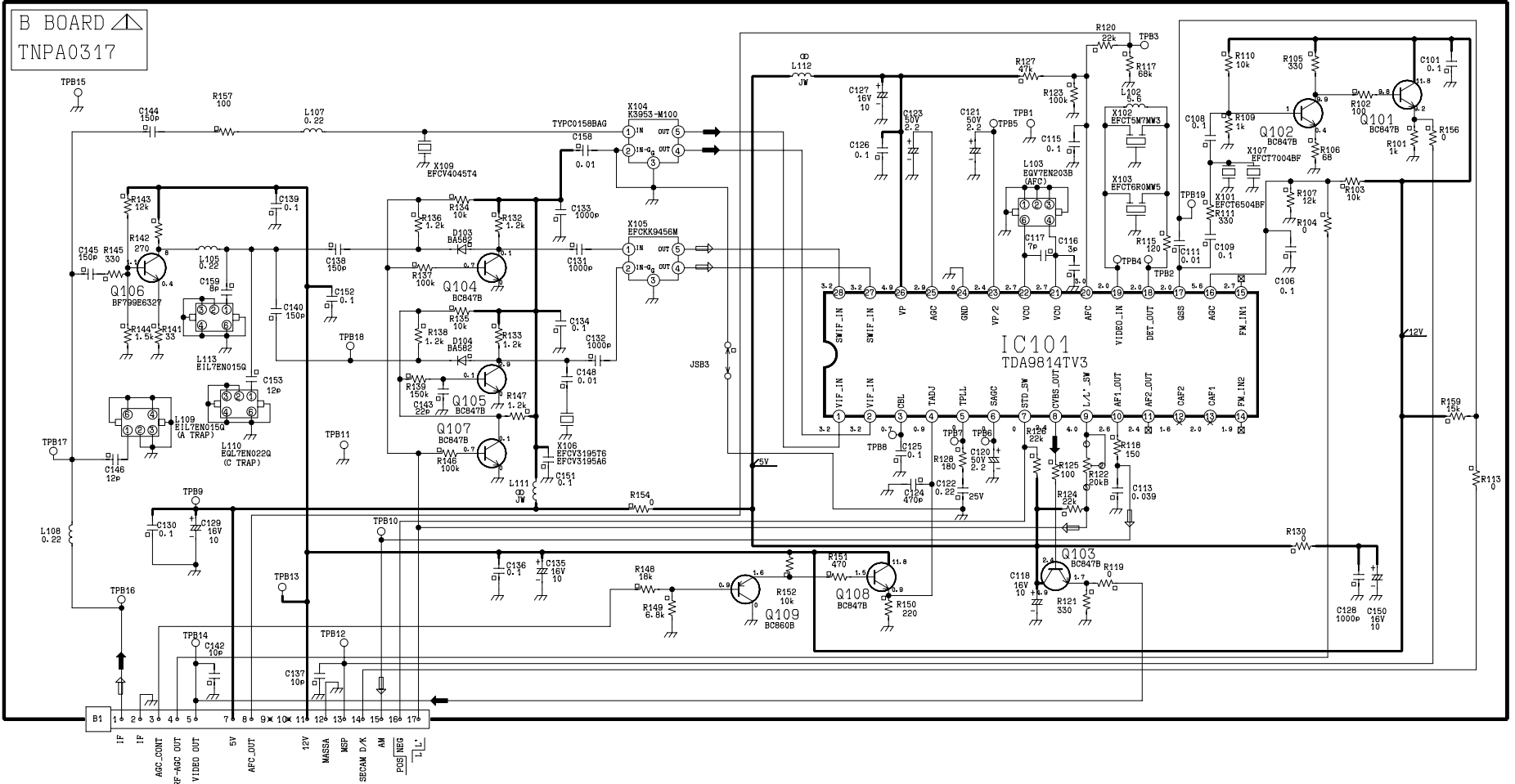

C SCHEMA

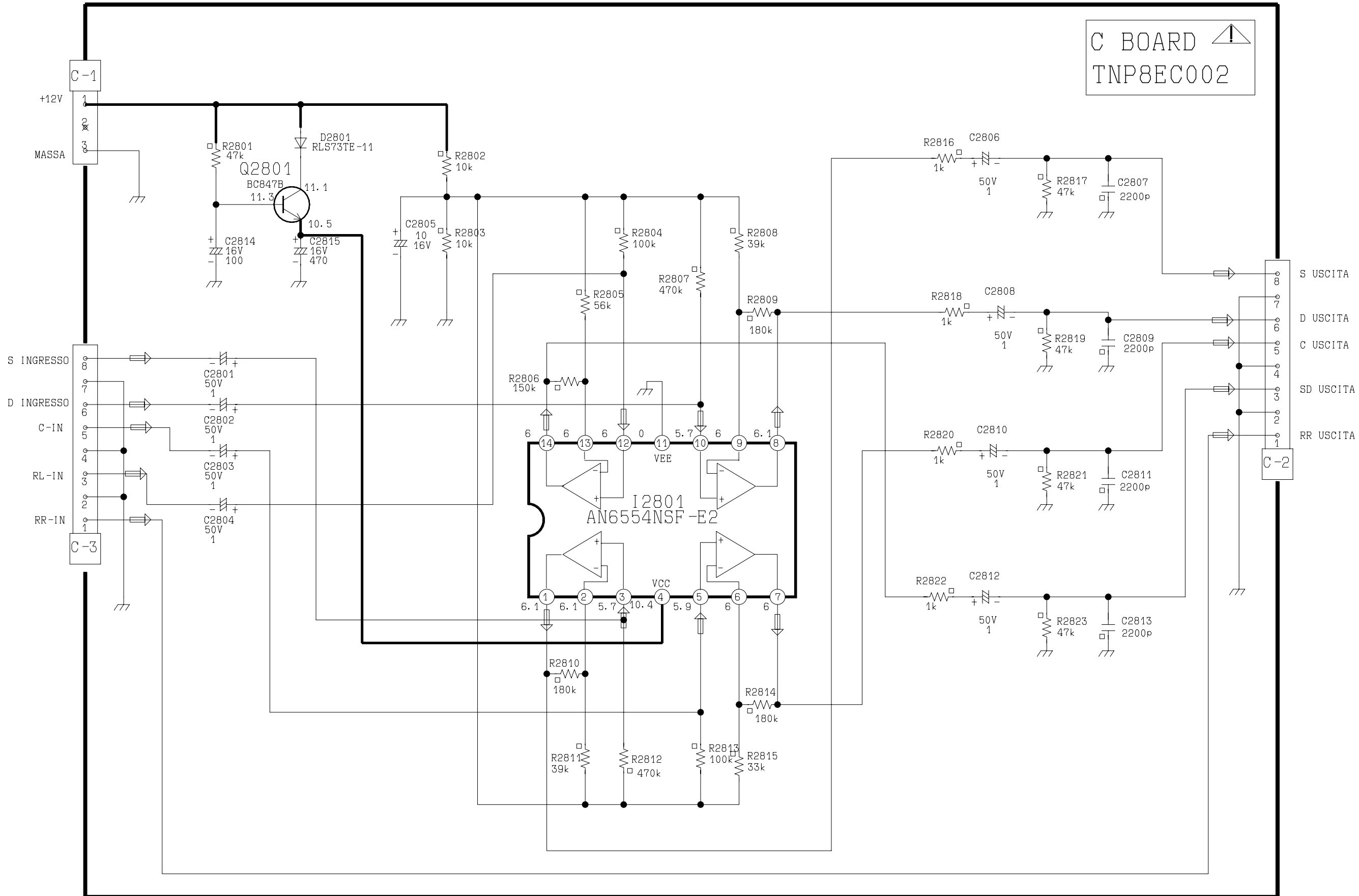

D - SCHEMA

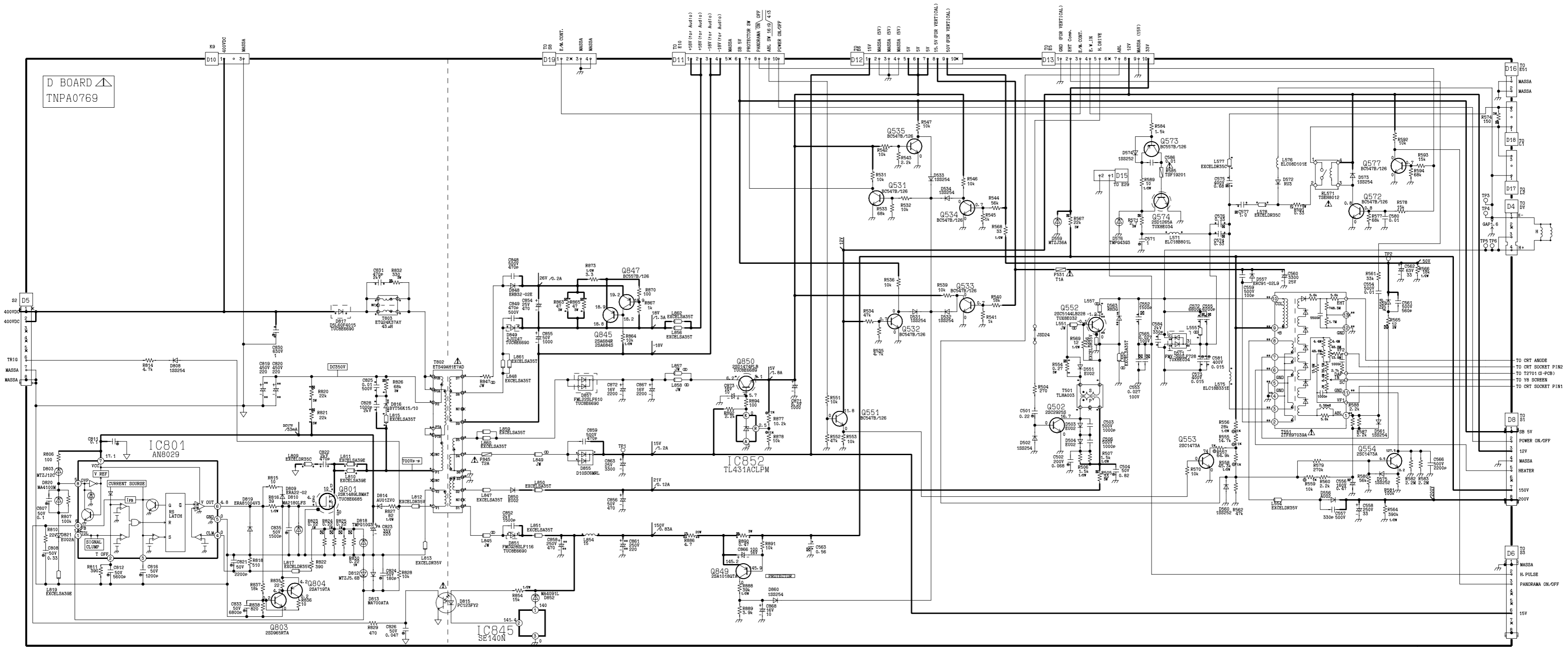

SCHEMA - E

FINALE VERTICALE, FINALI AUDIO, MICRO-PROCESSORE, TELEVIDEO, DECODER STEREO

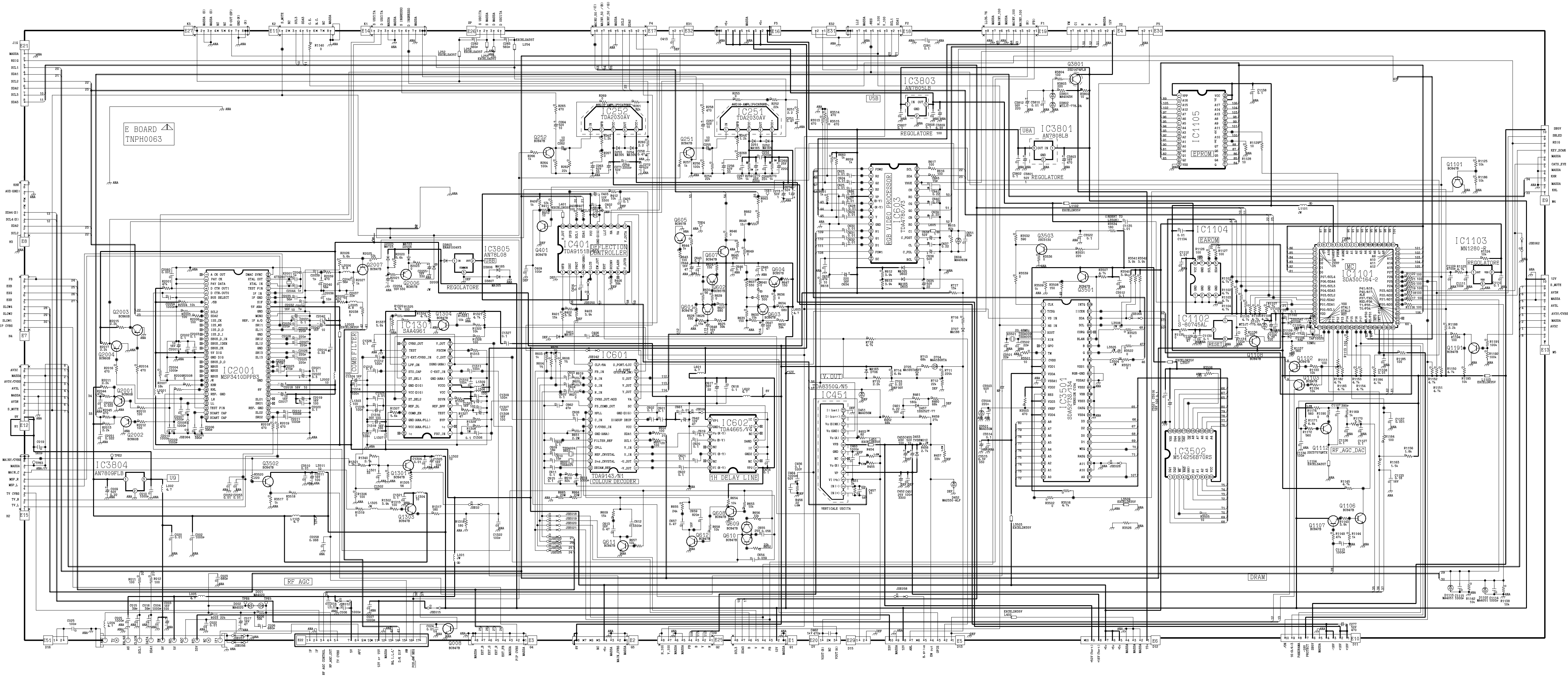

SCHEMA -F DIGITALE 100Hz

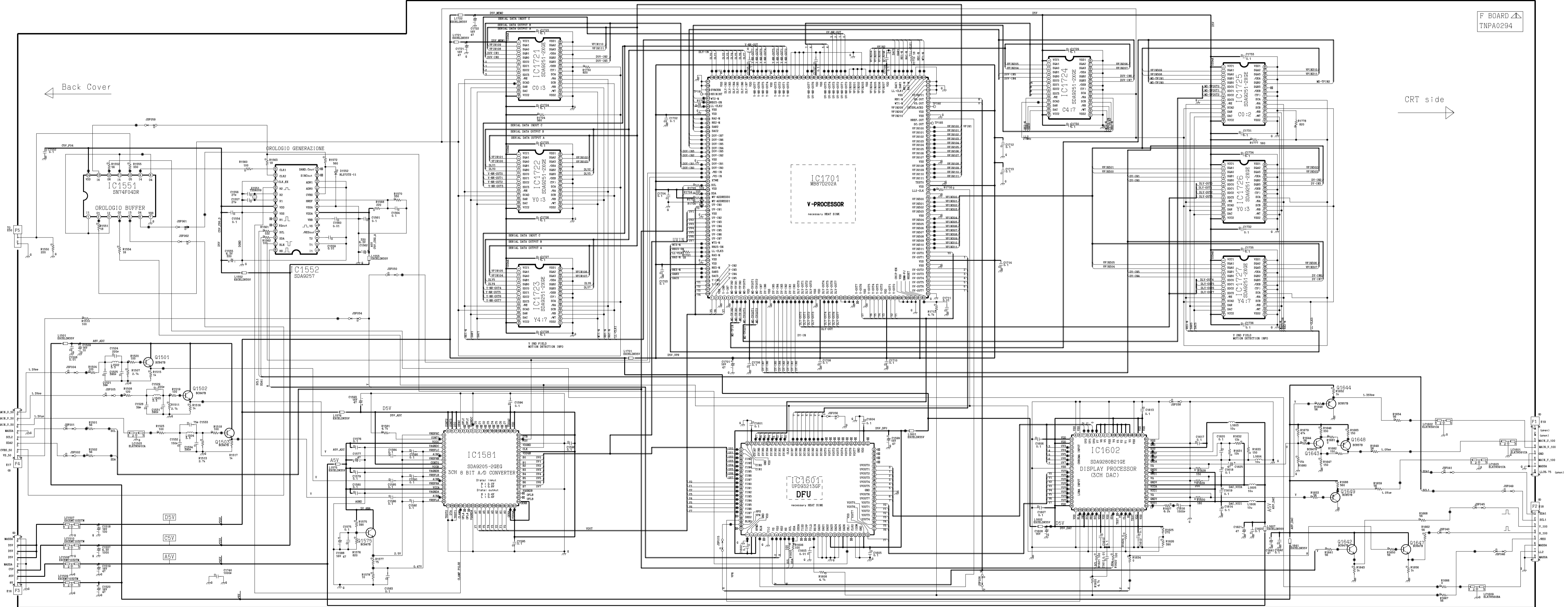

G SCHEMA

G BOARD ↗
TNPA0297

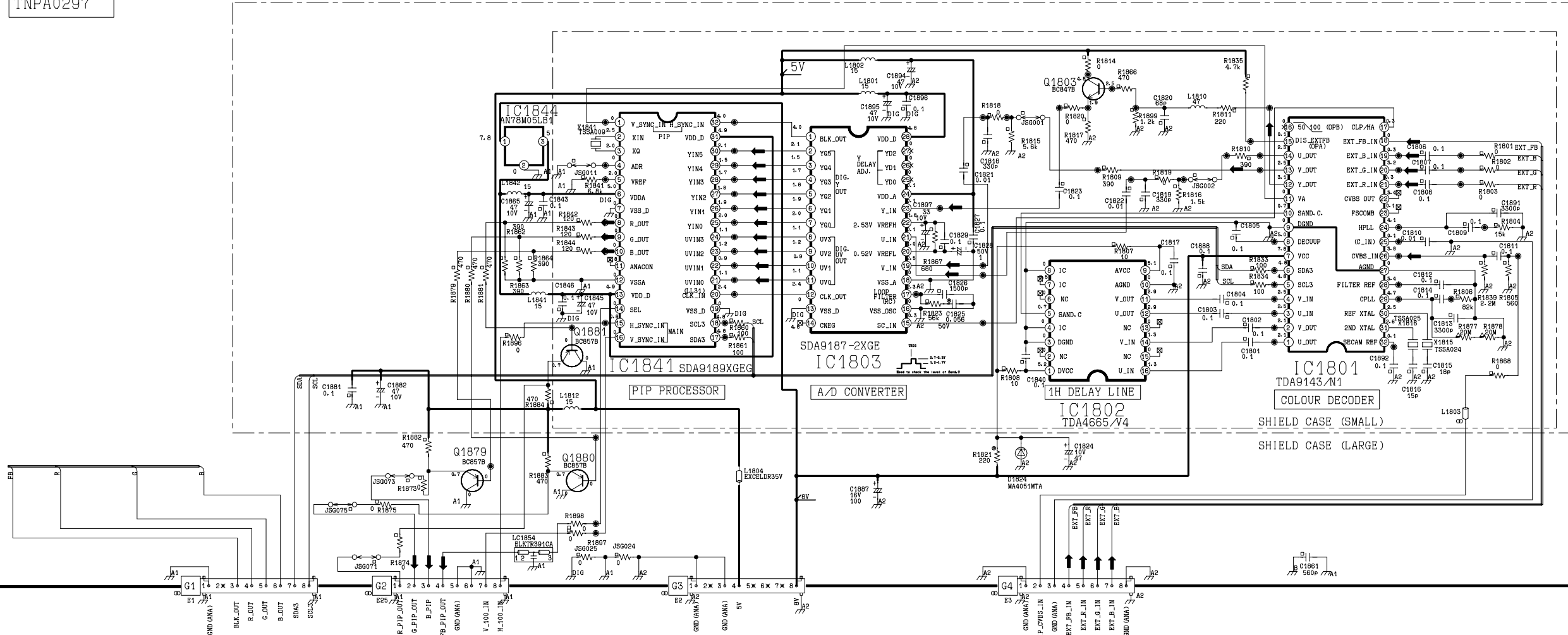

SCHEMA - H

COMMUTAZIONE A/V

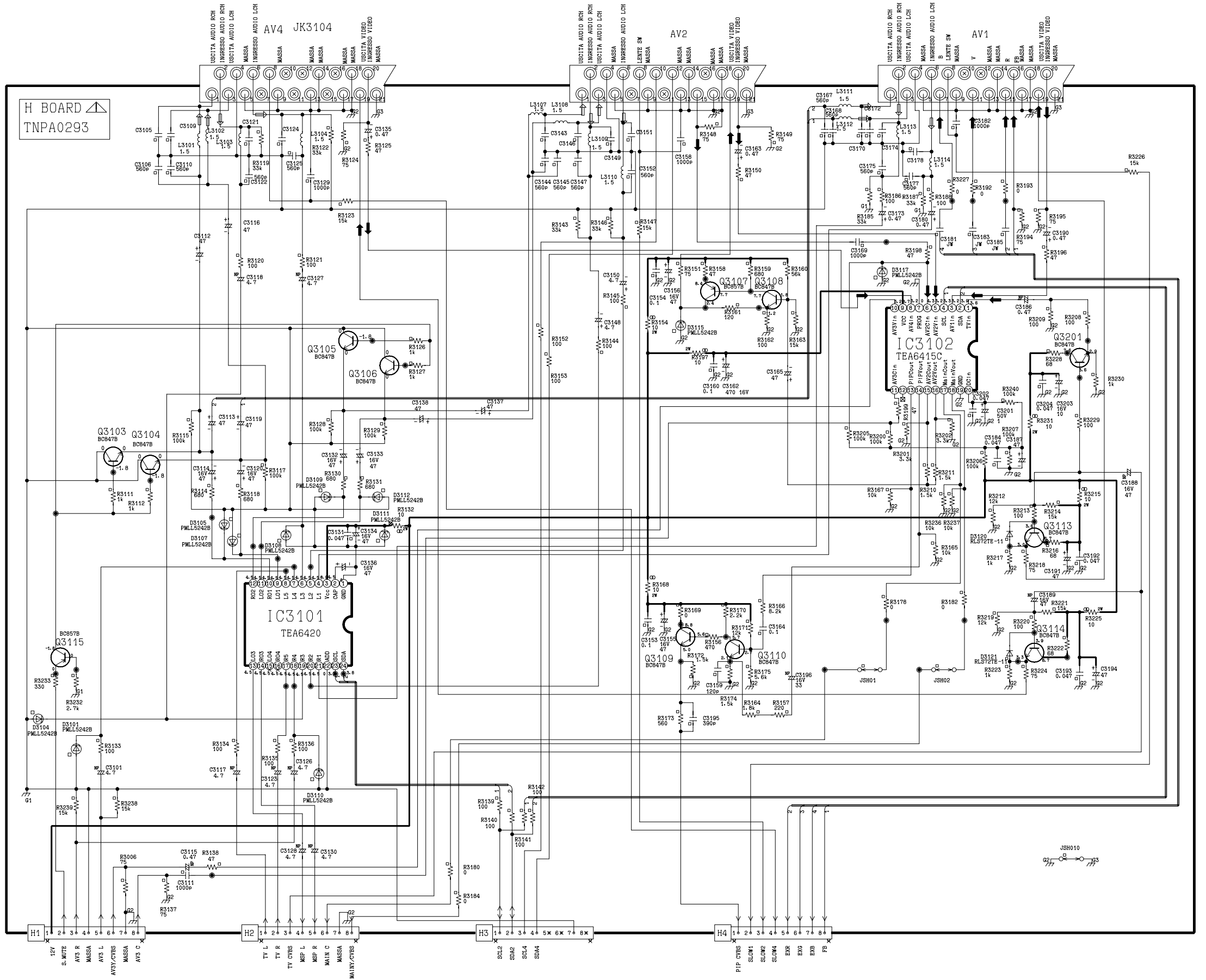

J - SCHEMA

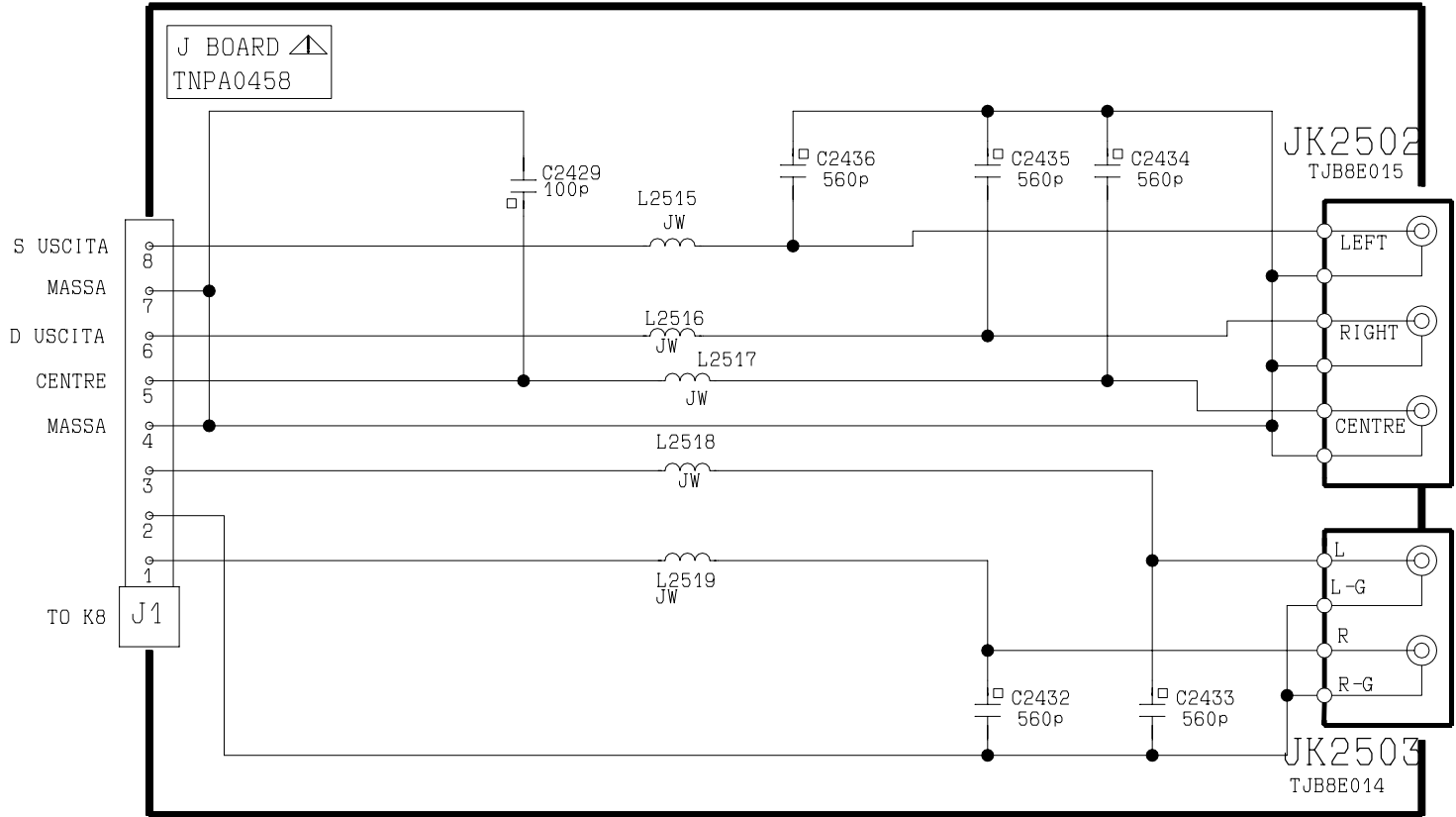

K SCHEMA

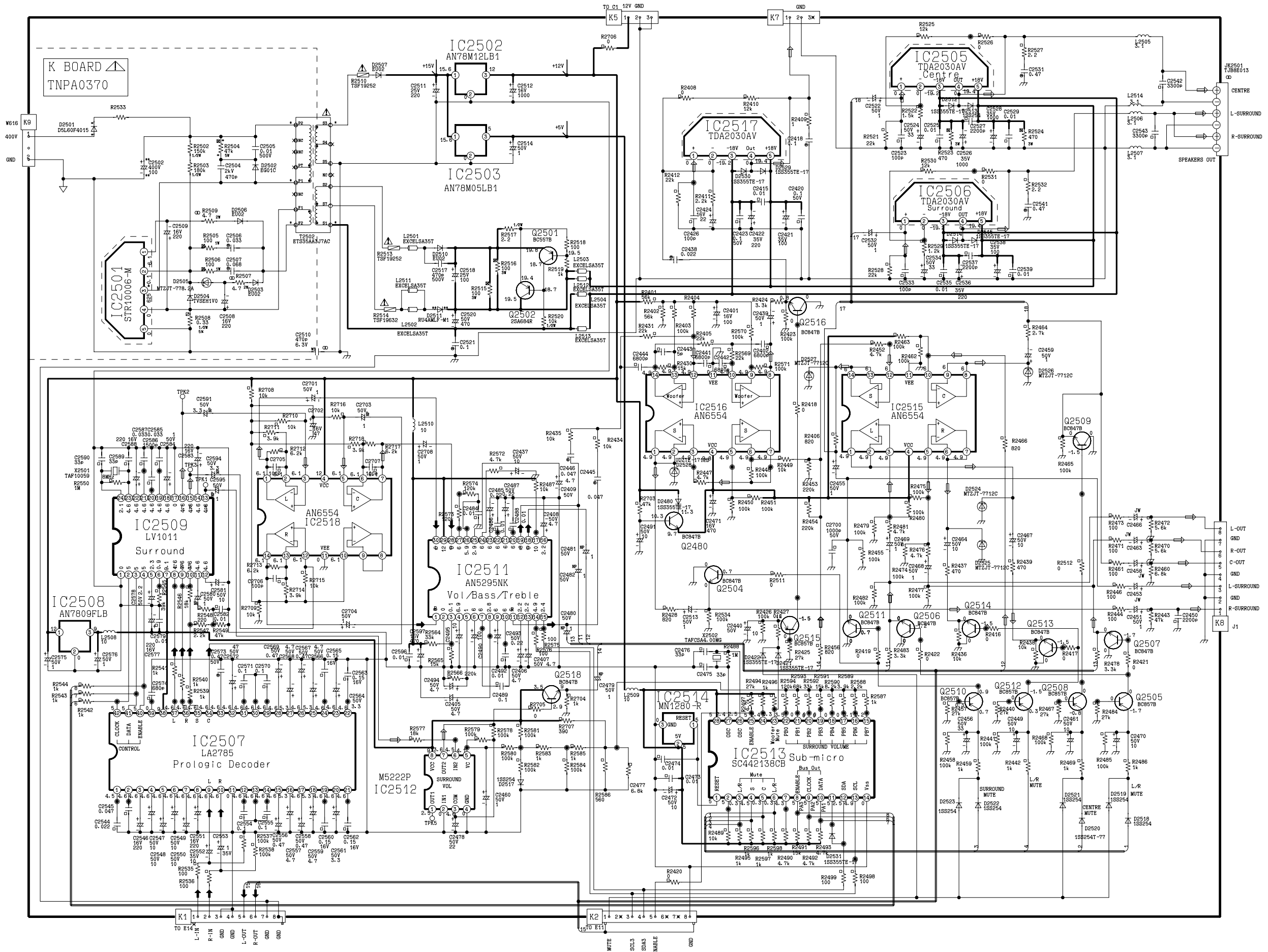

L - SCHEMA

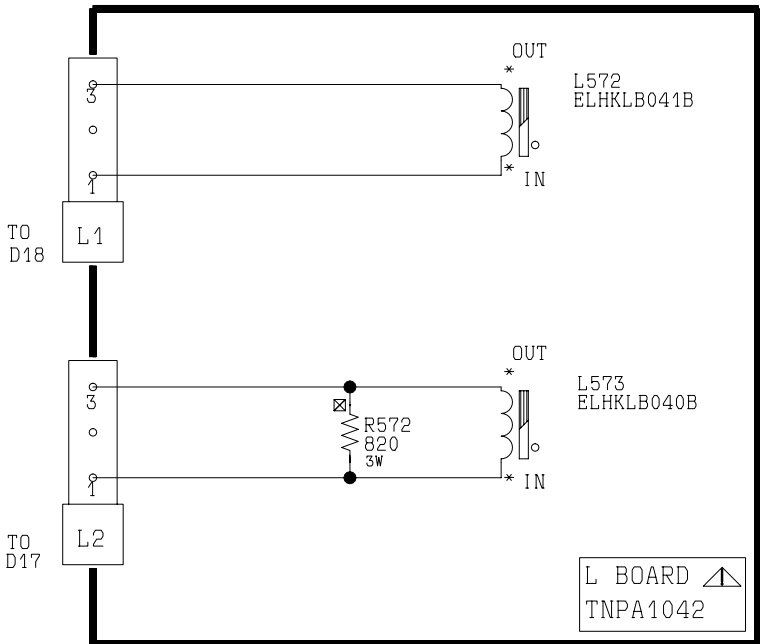

SCHEMA - M

RICEVITORE TELECOMANDO CONTROLLO

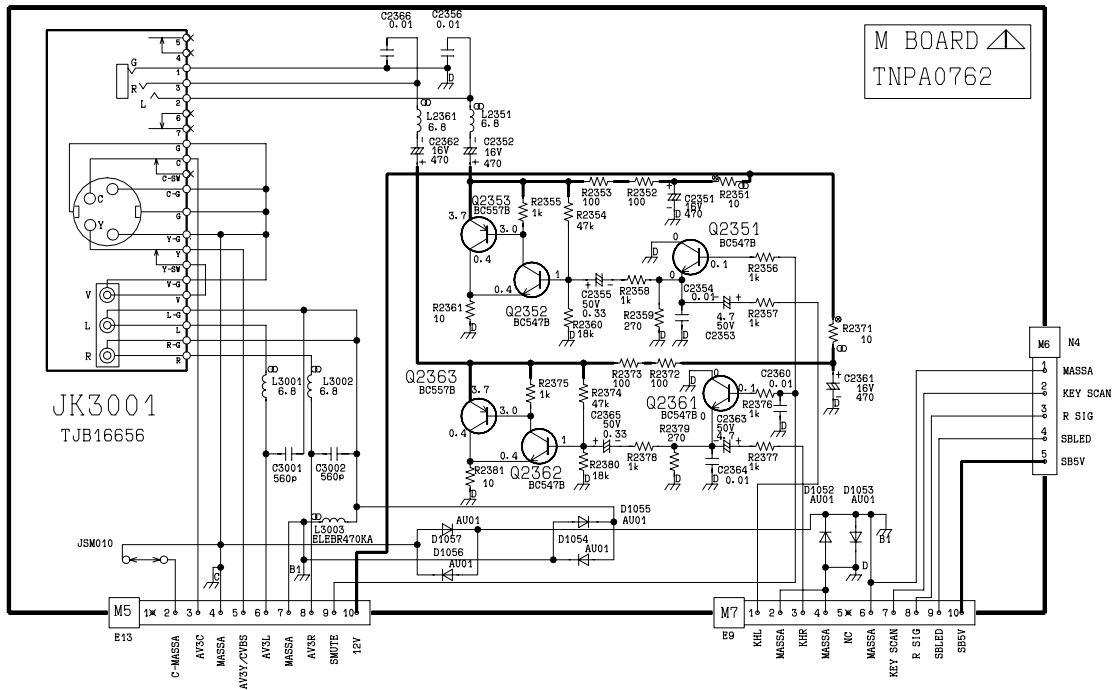

N-SCHEMA

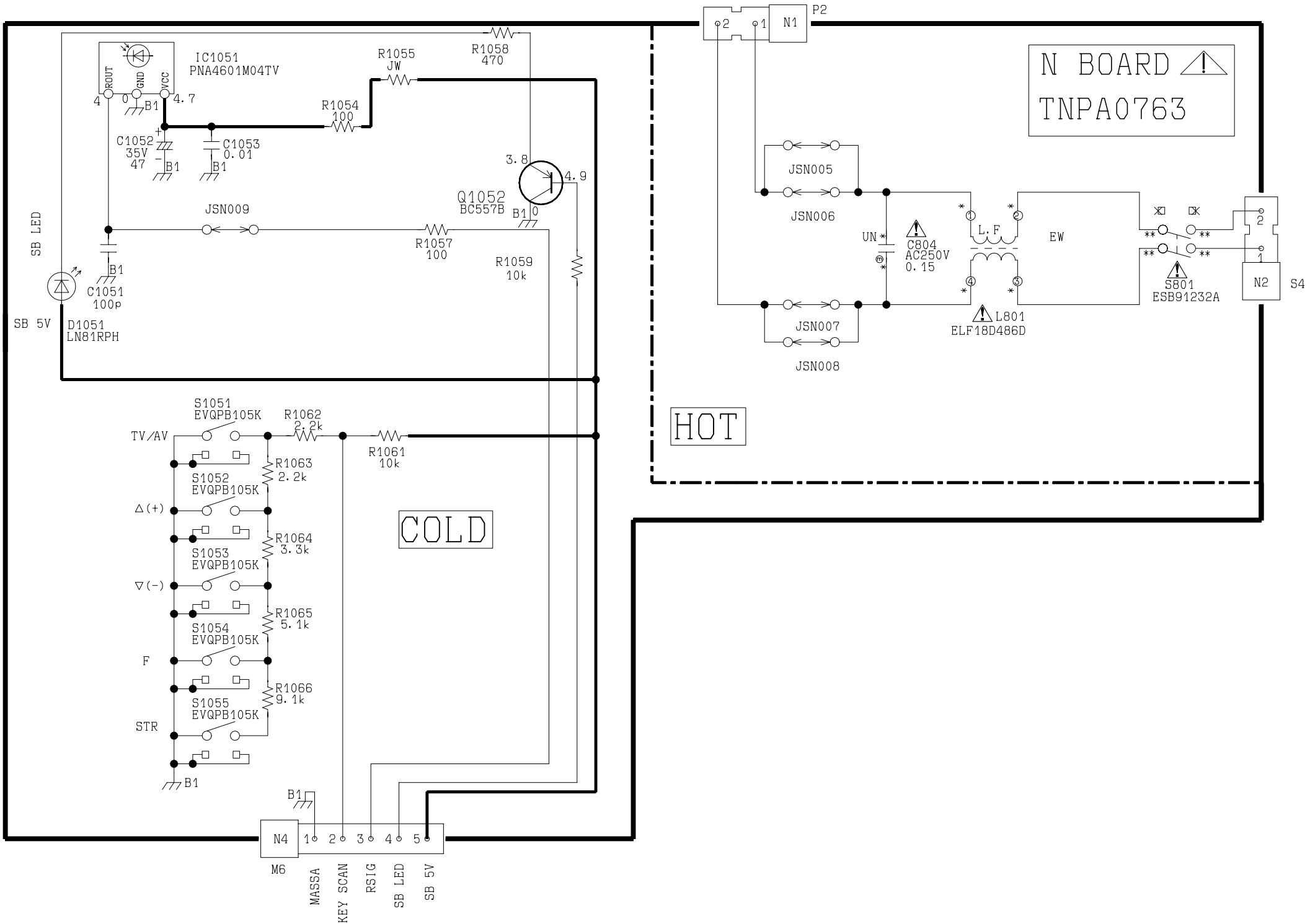

SCHEMA - P

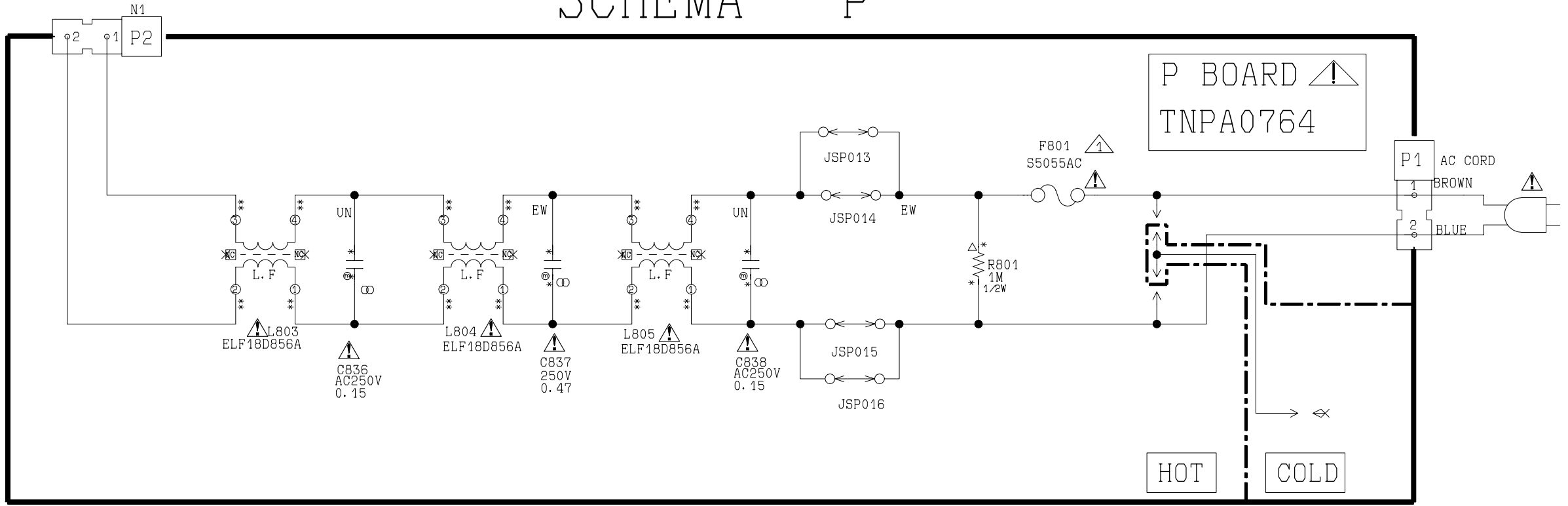

S SCHEMA

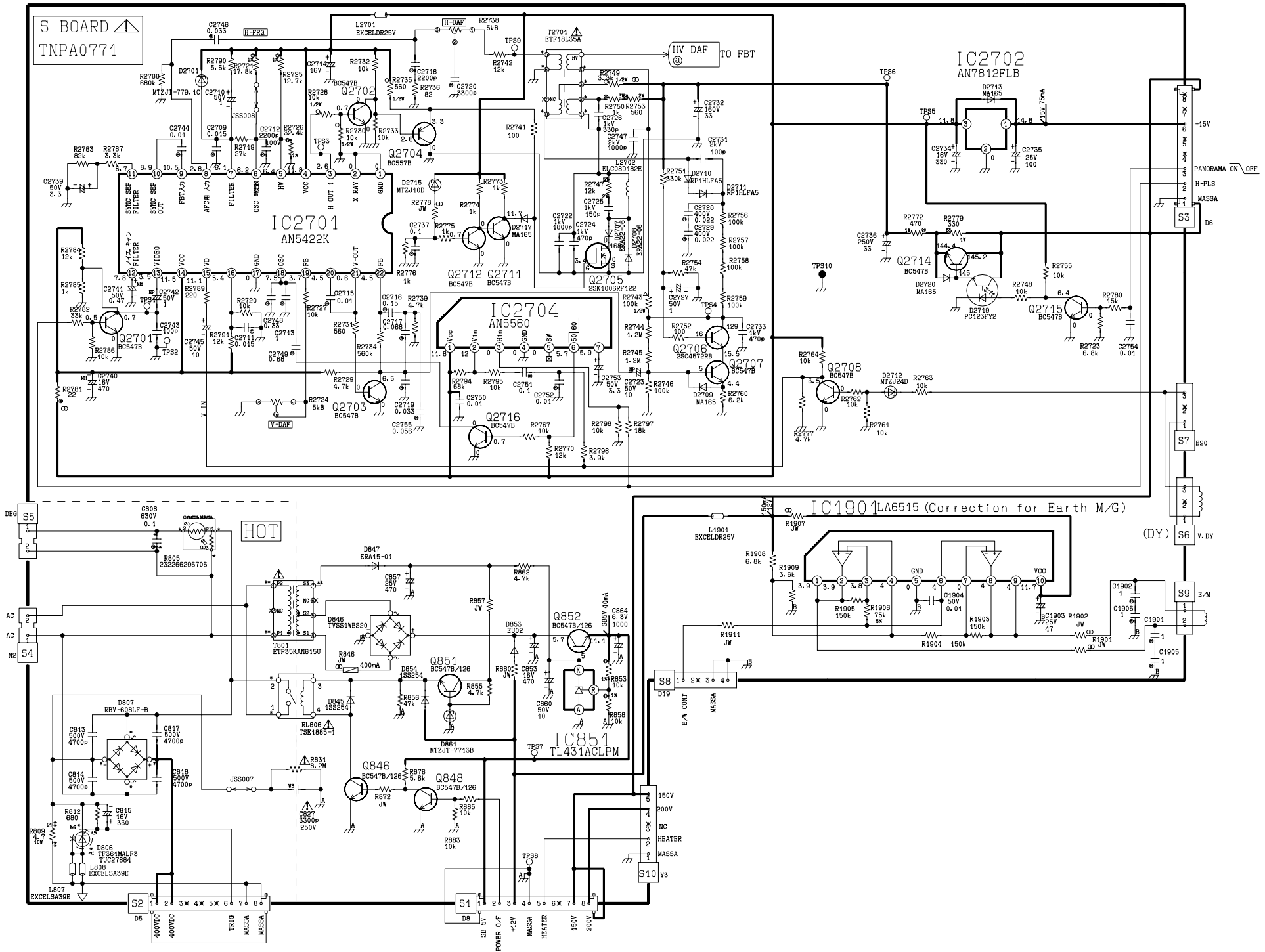

Y BOARD
TNPA0292

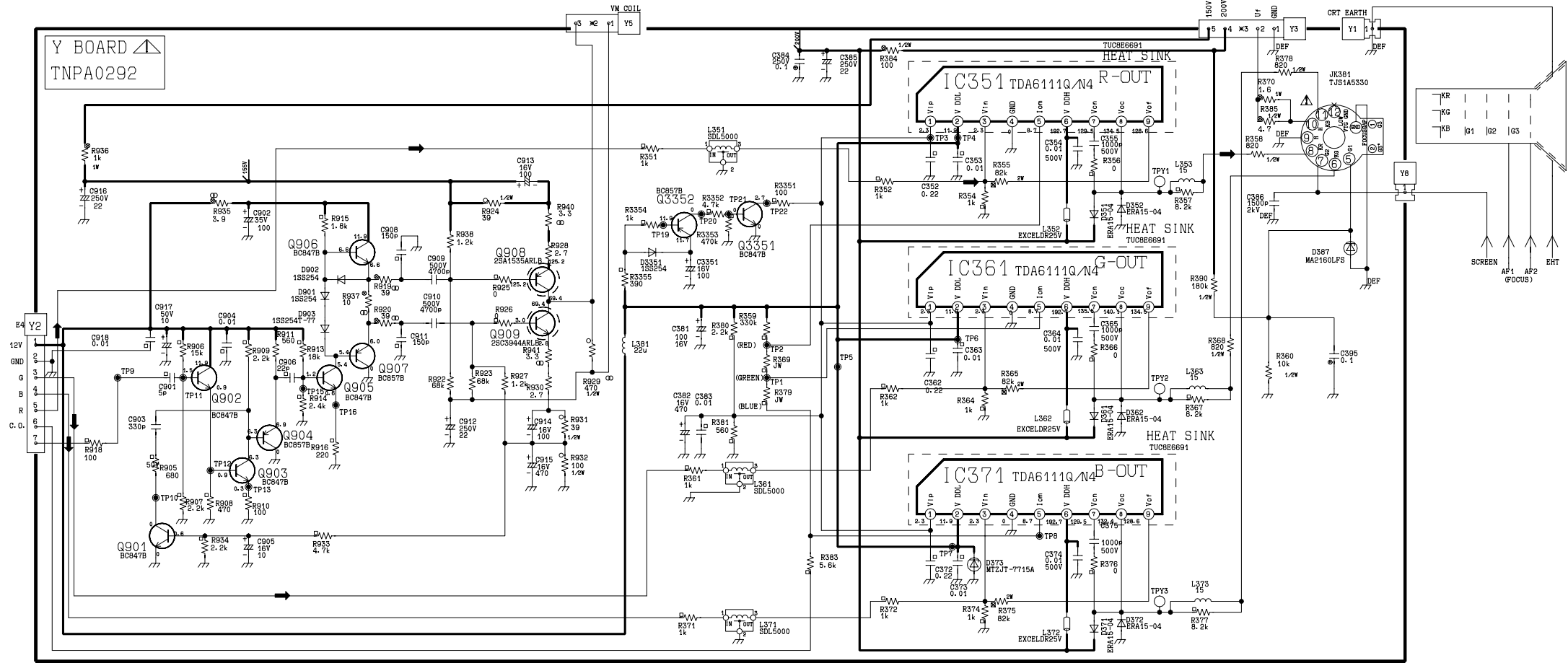

TNP A0317

(1) (B2)

SEE REVERSE FOR ORDER NO.

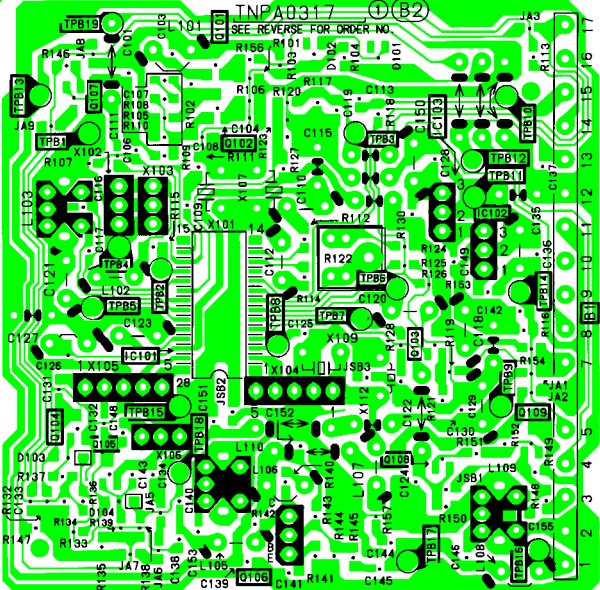

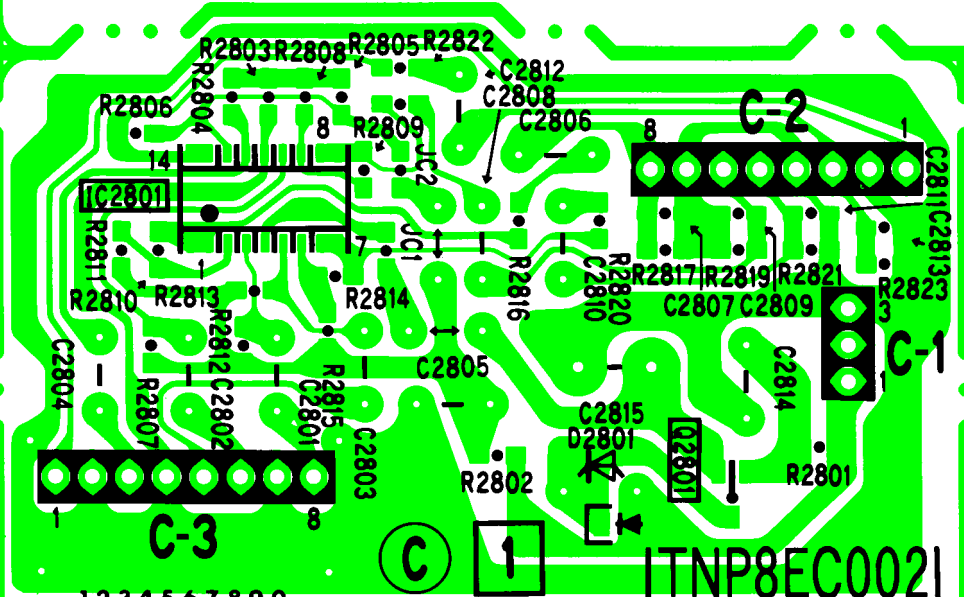

1 2 3 4 5 6 7 8 9 0

C

1

TNP8EC002

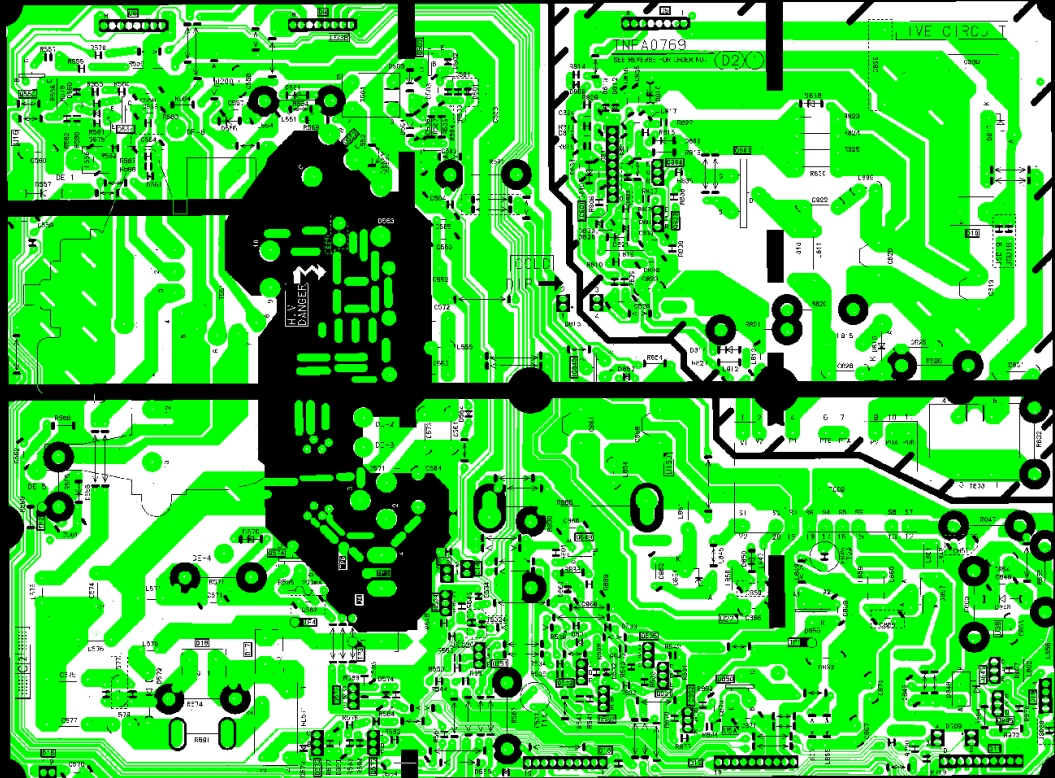

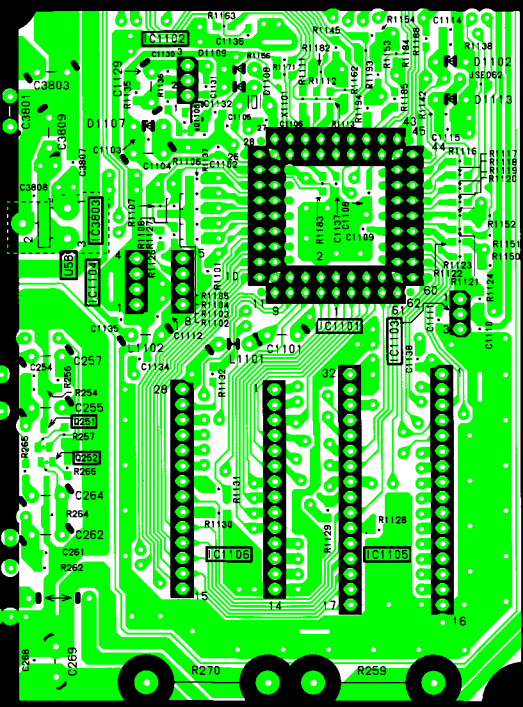
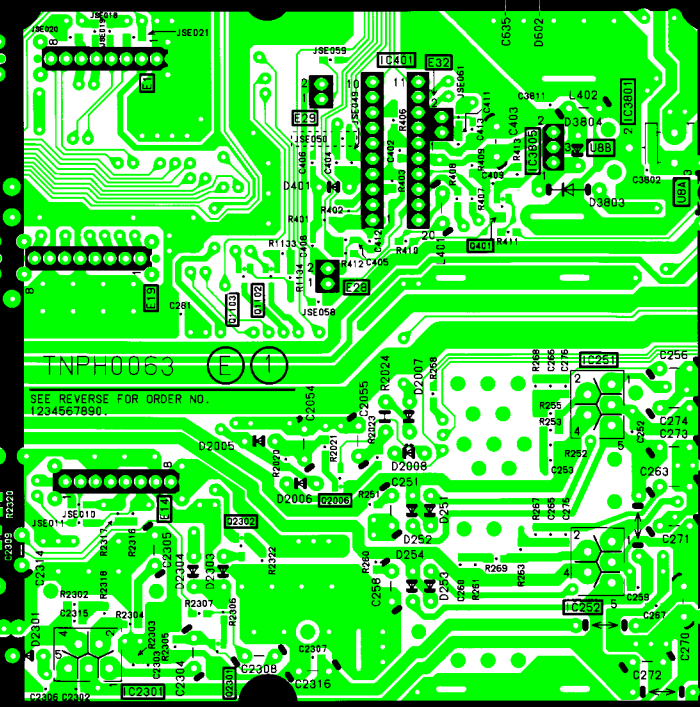
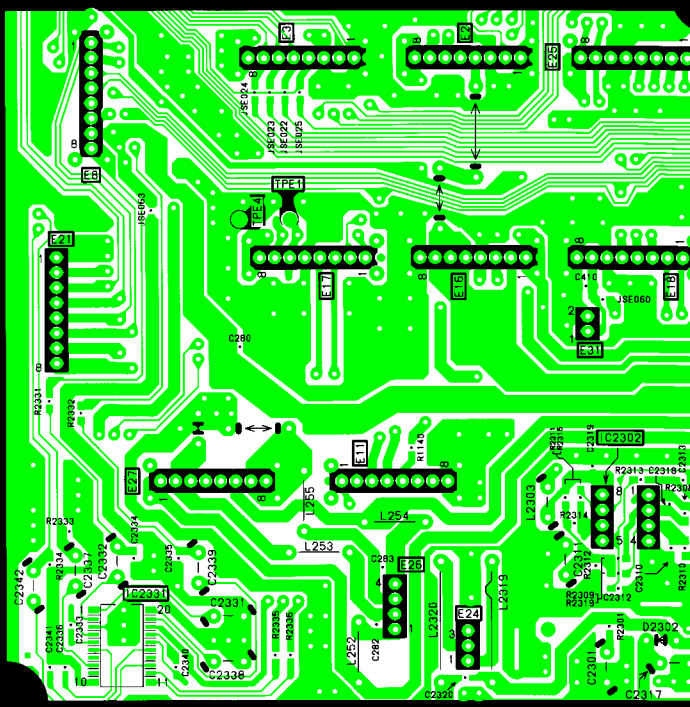
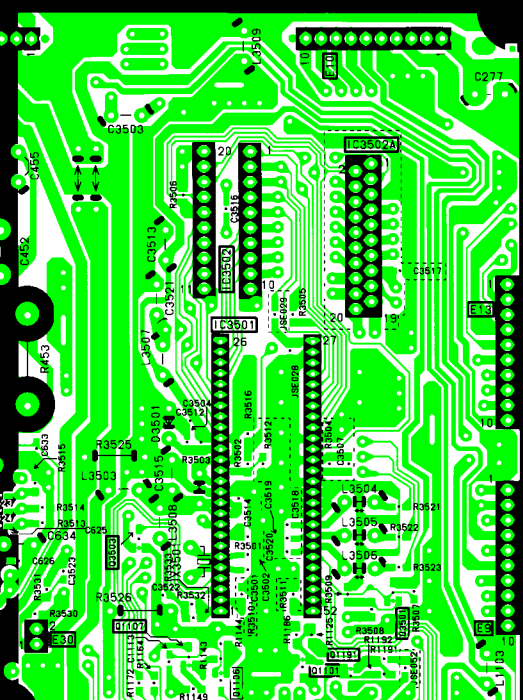
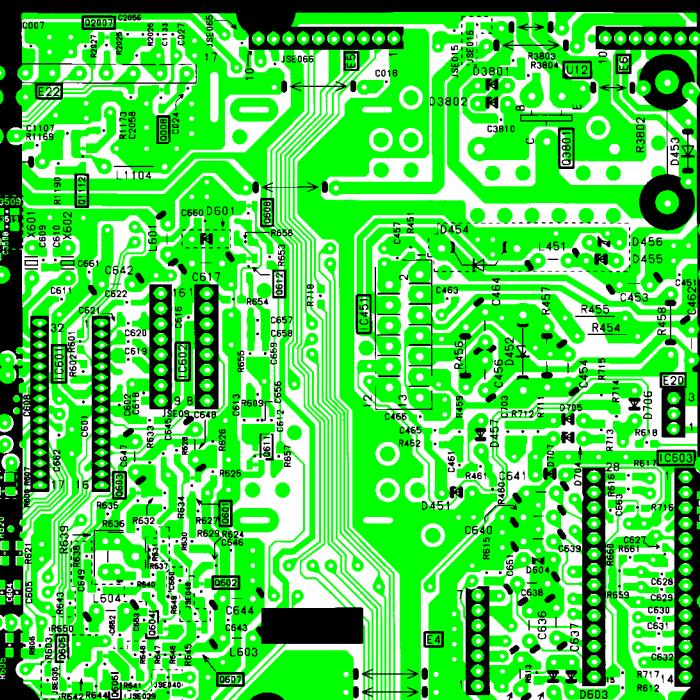
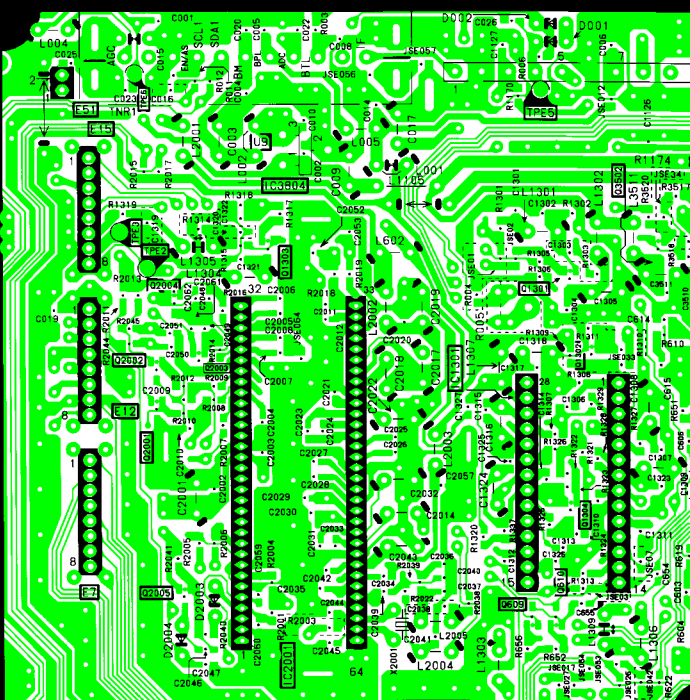

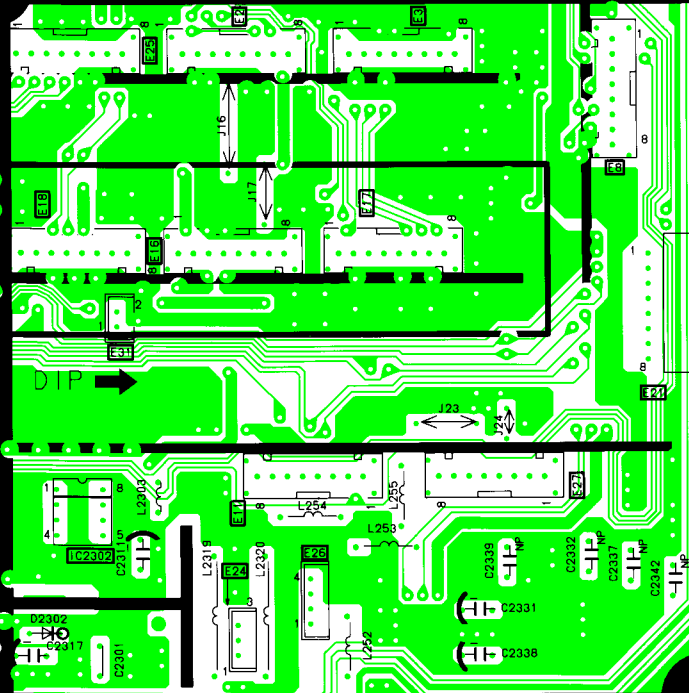
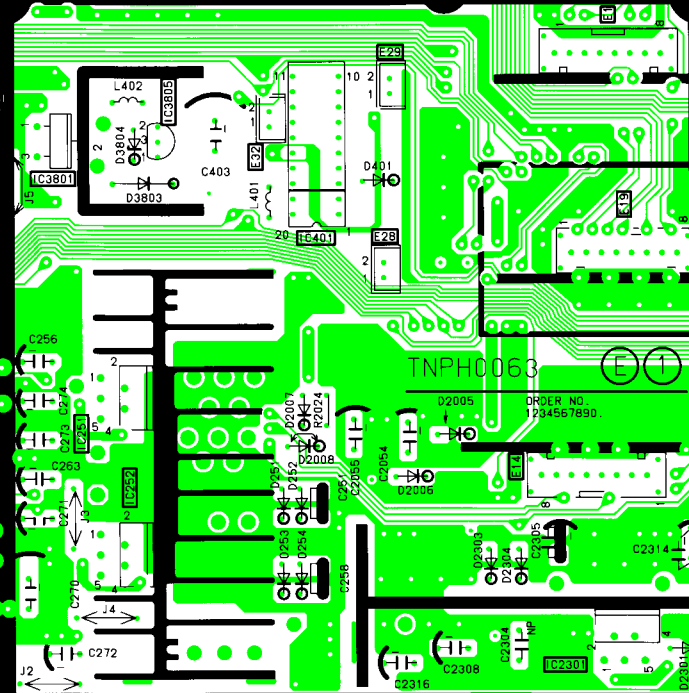
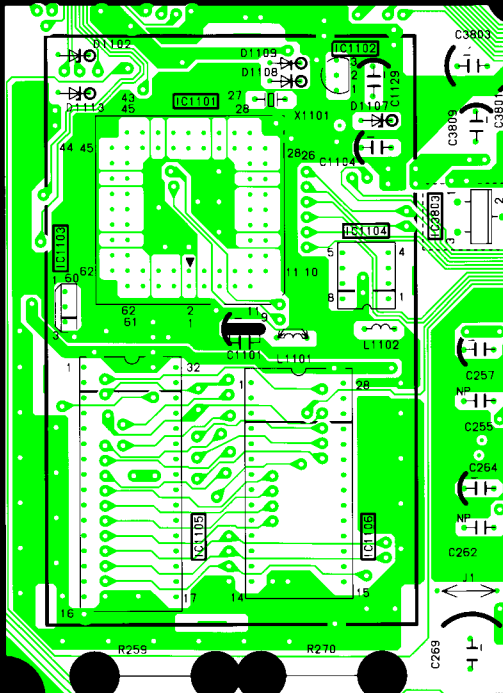
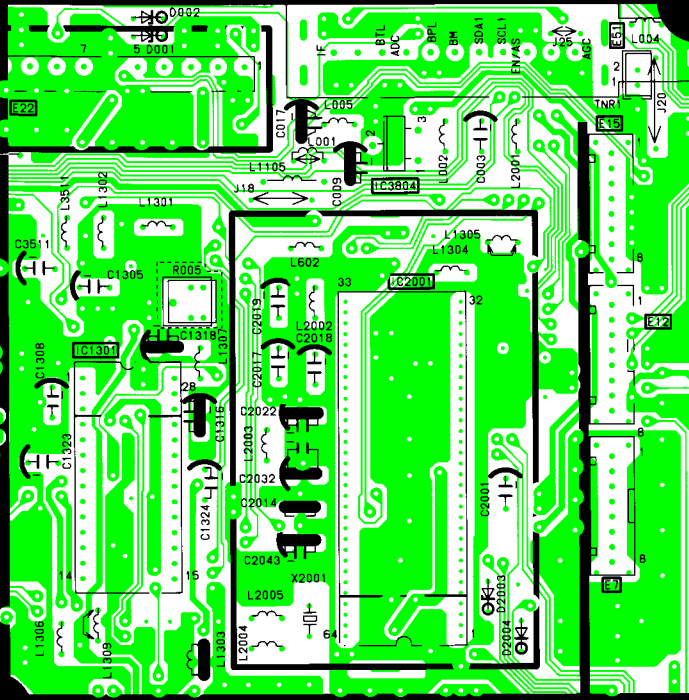
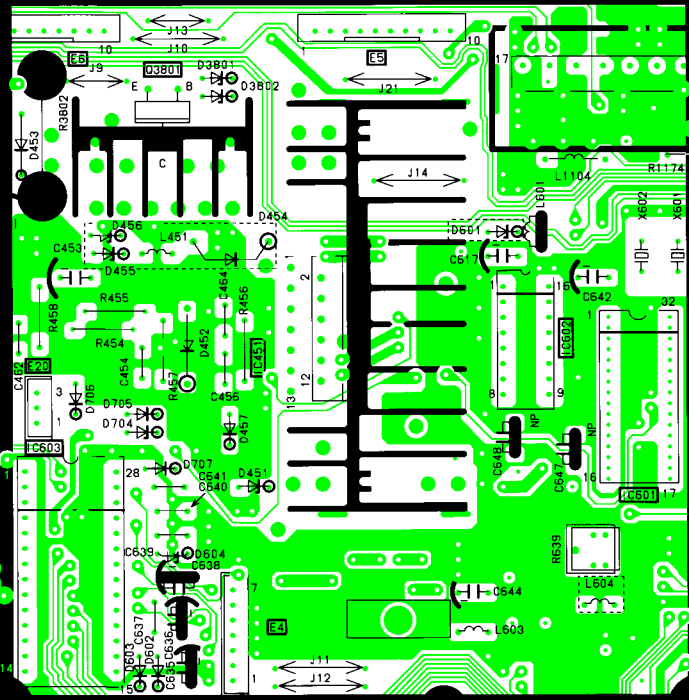
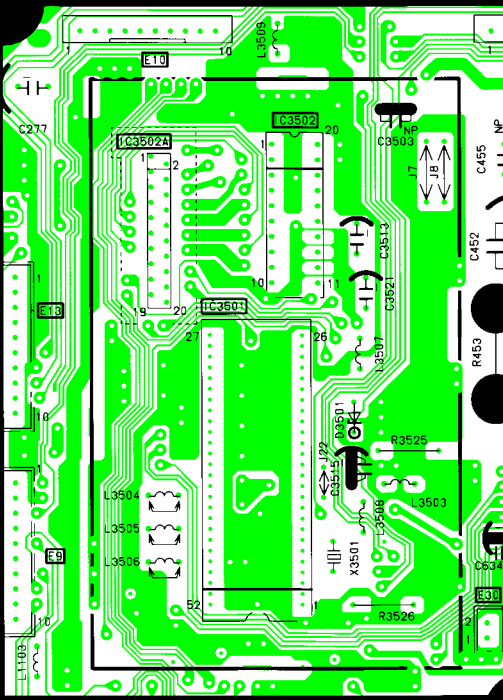

C1740

JF022

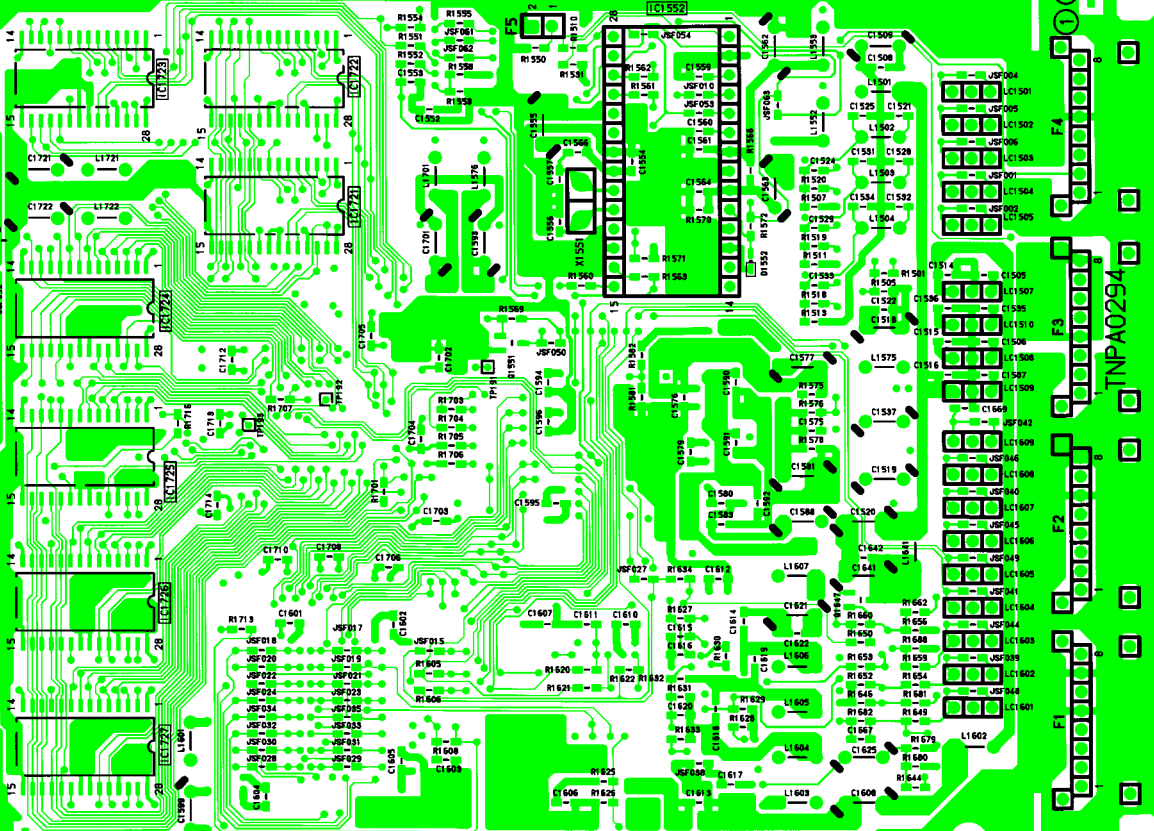

TNP A0294

INPA0297

SEE REVERSE FOR ORDER NO.

(G) 1

REF NO. 1...SERIES

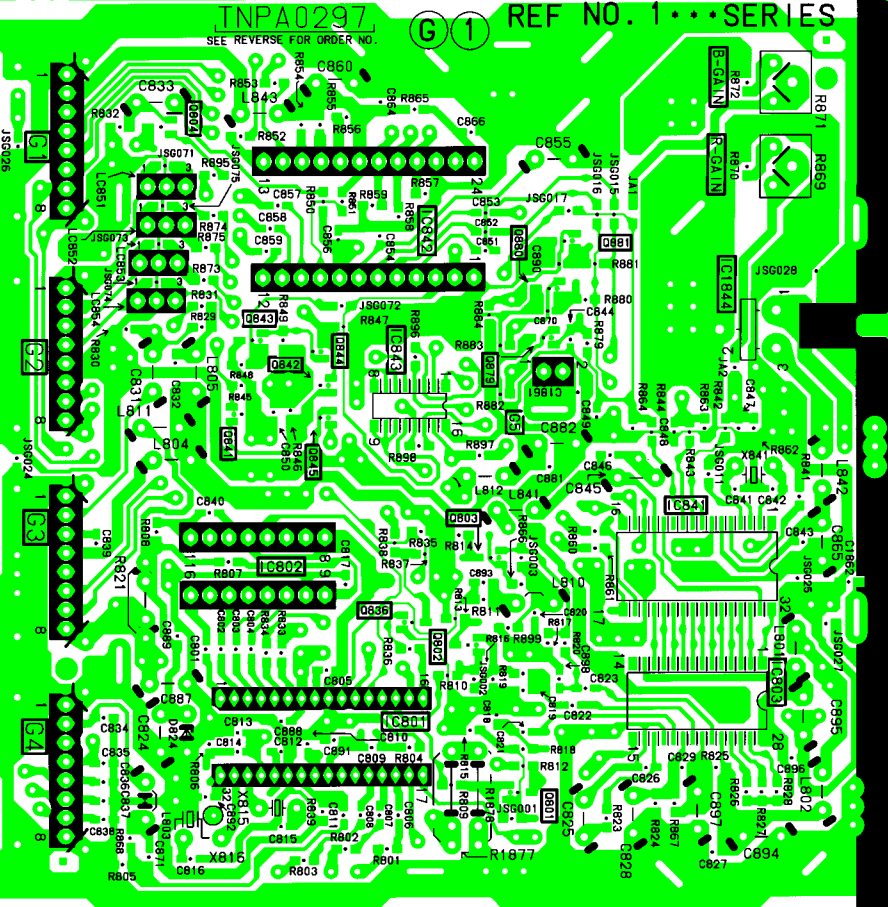

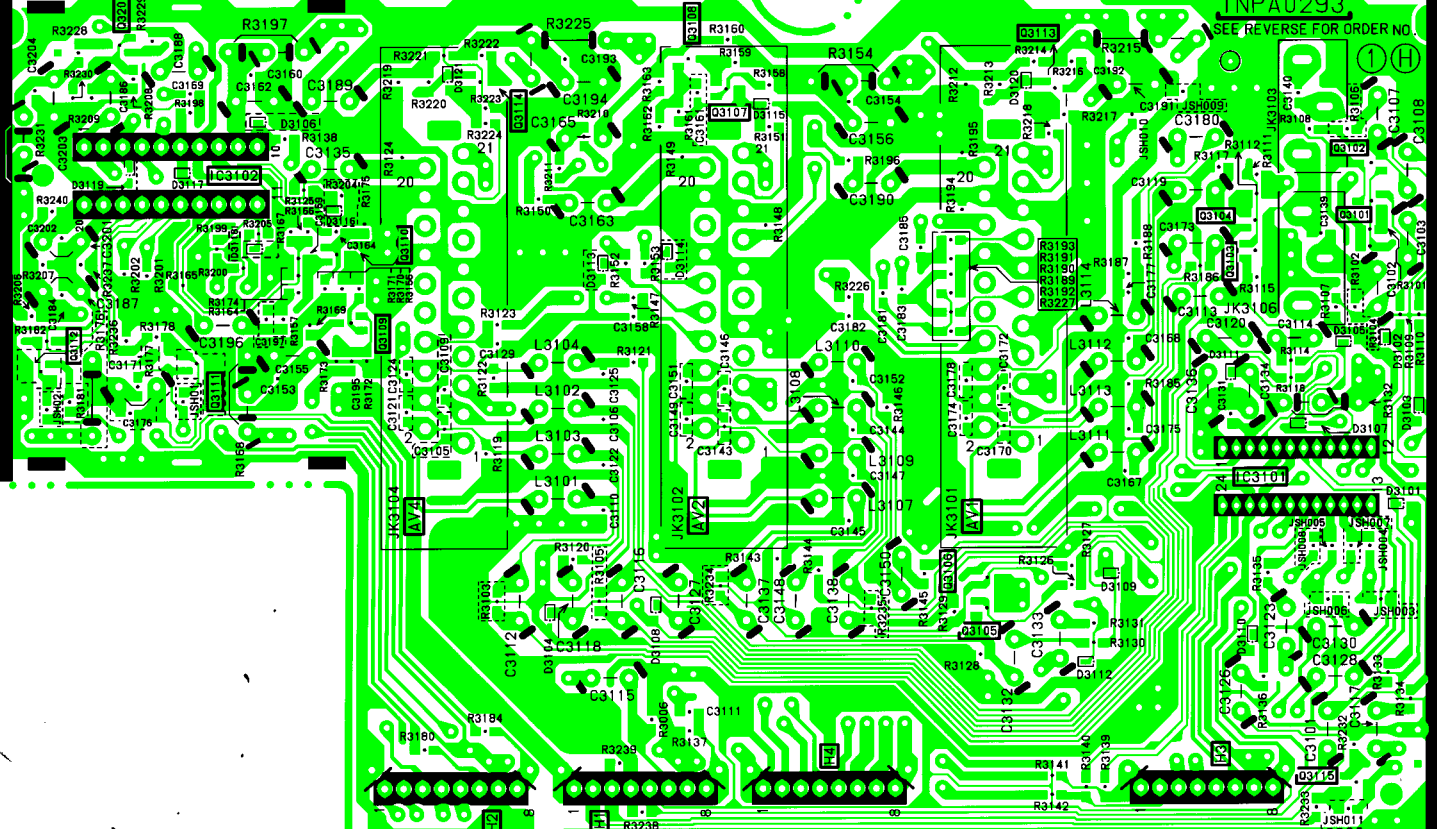

(1) (H)



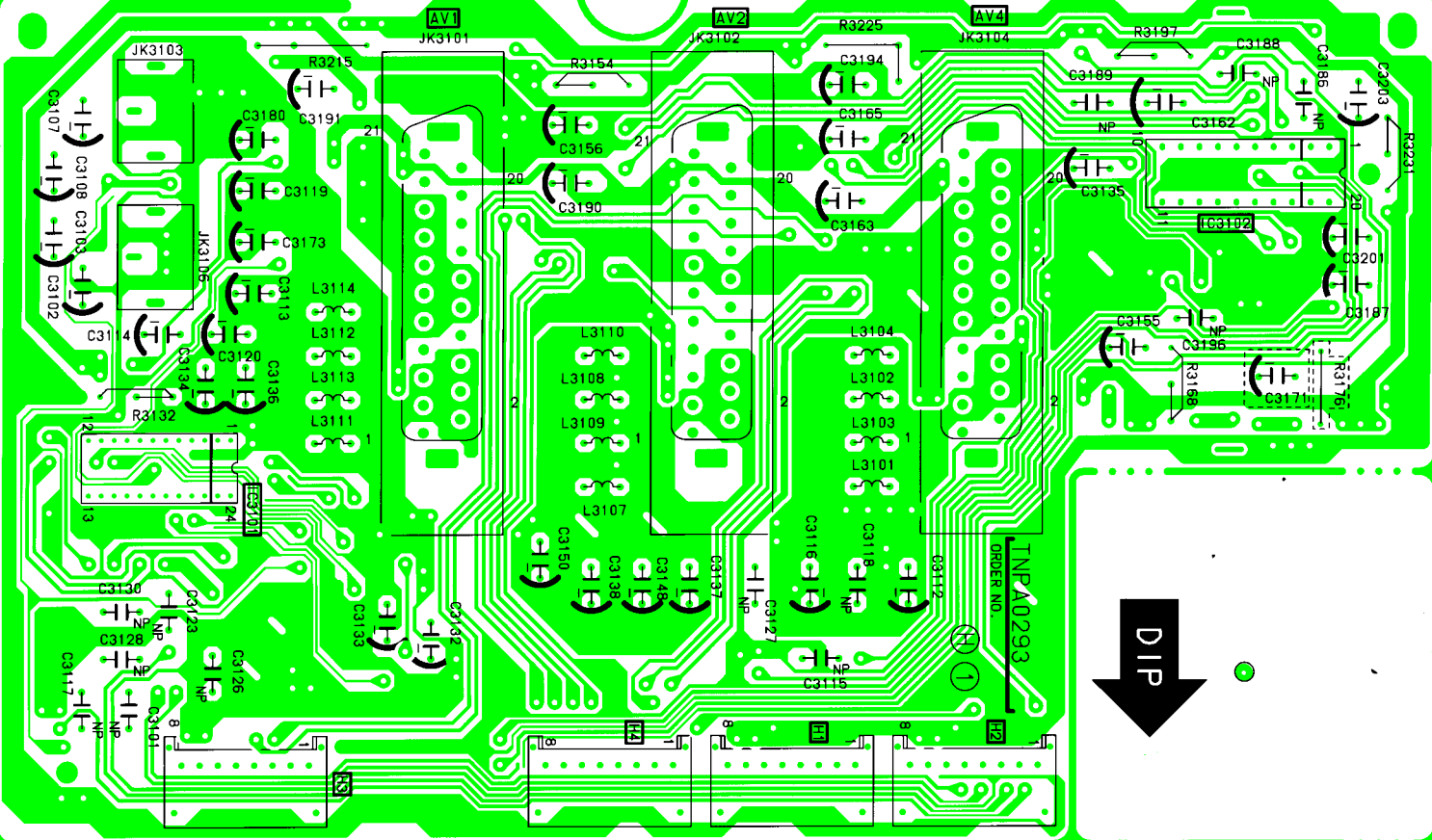

DIP

TNP40293

ORDER NO.

AV1

AV2

AV4

LC3102

AV3

AV5

AV6

AV7

AV8

AV9

AV10

AV11

AV12

AV13

AV14

AV15

AV16

AV17

AV18

AV19

AV20

AV21

AV22

AV23

AV24

AV25

AV26

AV27

AV28

AV29

AV30

AV31

AV32

AV33

AV34

AV35

AV36

AV37

AV38

AV39

AV40

AV41

AV42

AV43

AV44

AV45

AV46

AV47

AV48

AV49

AV50

AV51

AV52

AV53

AV54

AV55

AV56

AV57

AV58

AV59

AV60

AV61

AV62

AV63

AV64

AV65

AV66

AV67

AV68

AV69

AV70

AV71

AV72

AV73

AV74

AV75

AV76

AV77

AV78

AV79

AV80

AV81

AV82

AV83

AV84

AV85

AV86

AV87

AV88

AV89

AV90

AV91

AV92

AV93

AV94

AV95

AV96

AV97

AV98

AV99

AV100

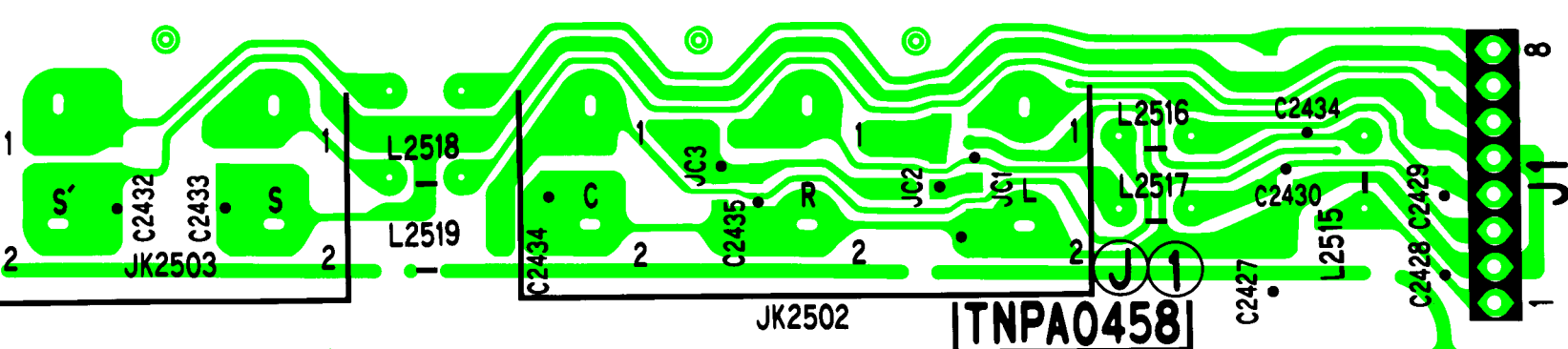

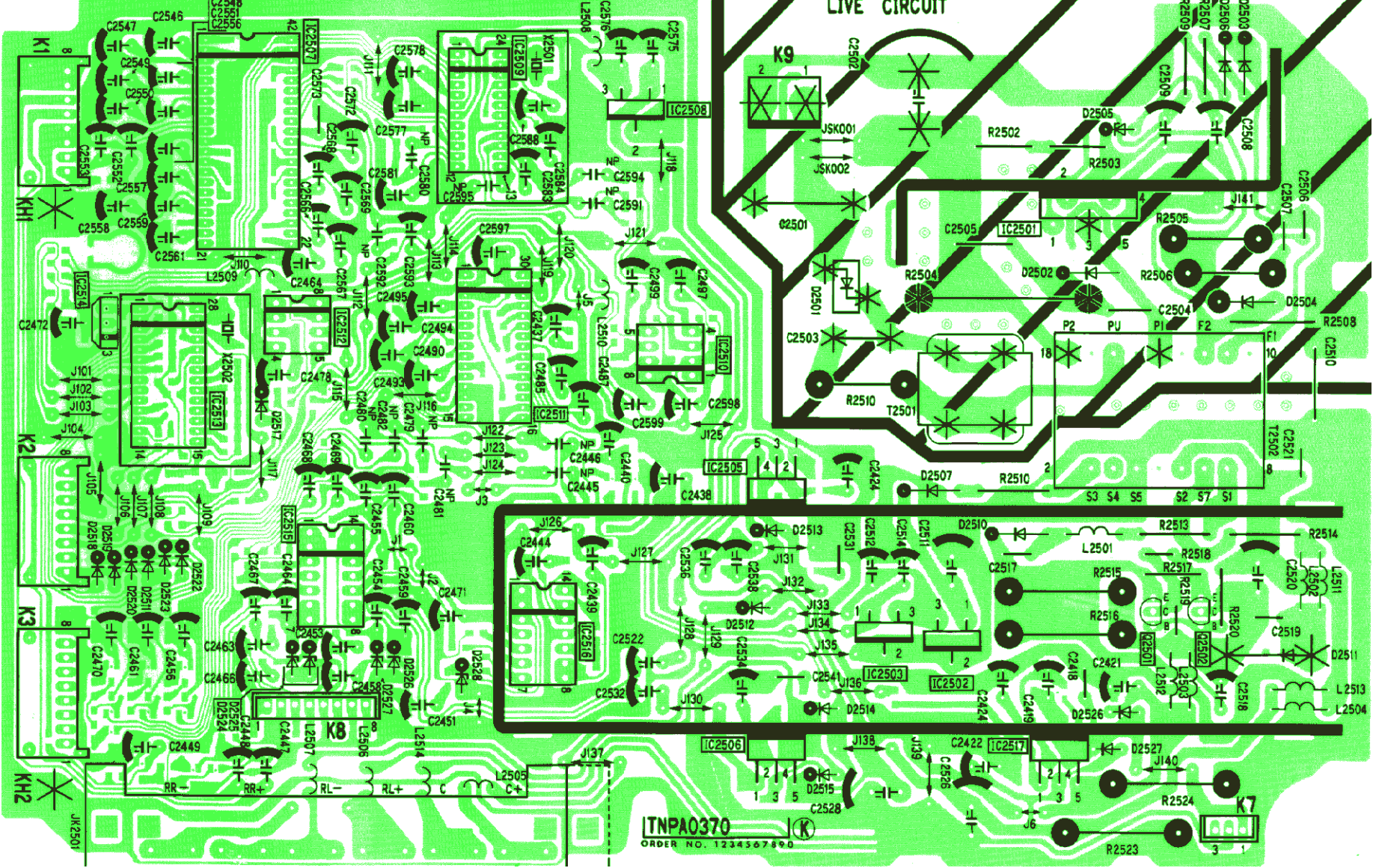

INPA0370
ORDER NO. 1234567890

⋮⋮⋮⋮	C	2	⋮⋮⋮⋮
------	---	---	------

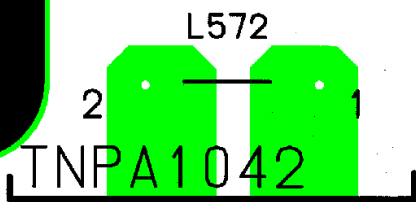

SEE REVERSE FOR ORDER NO.

① ②

L1

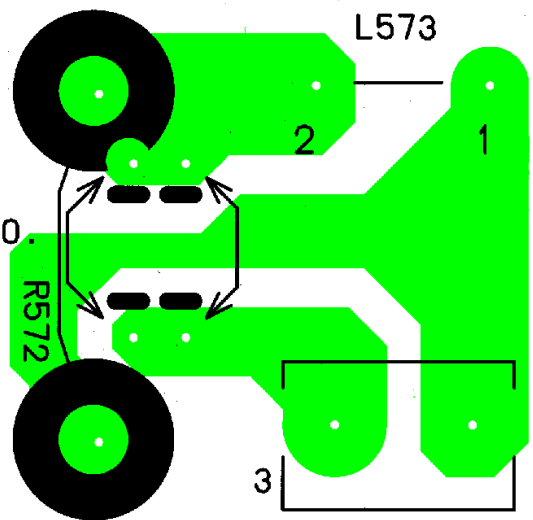
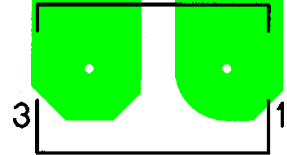

L2

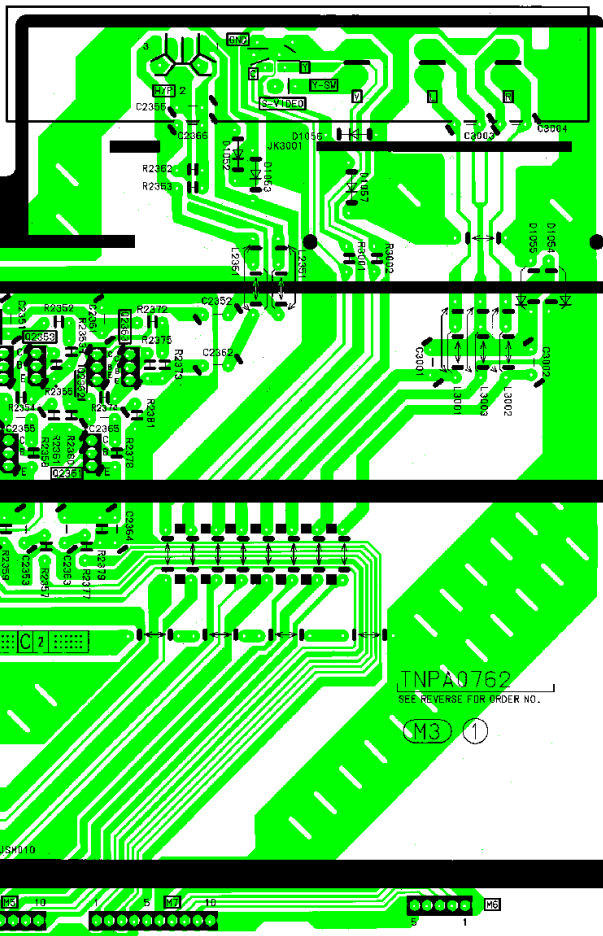

TNPA0762 (M3) ①

LIVE CIRCUIT

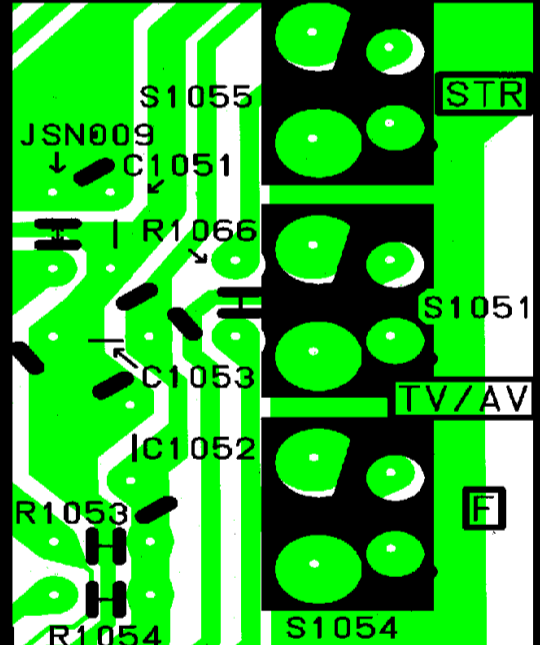
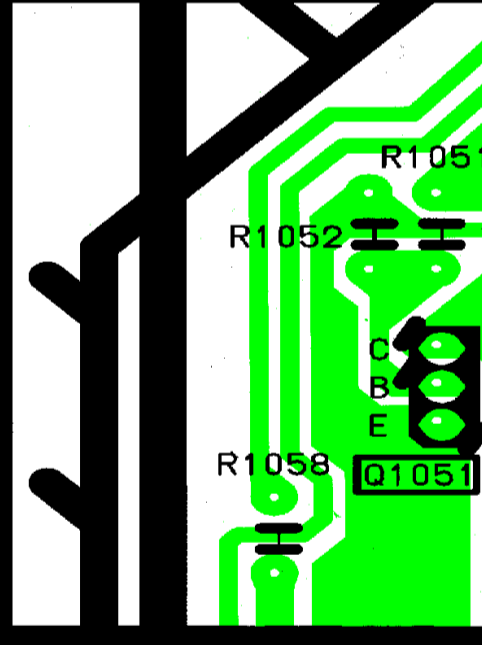
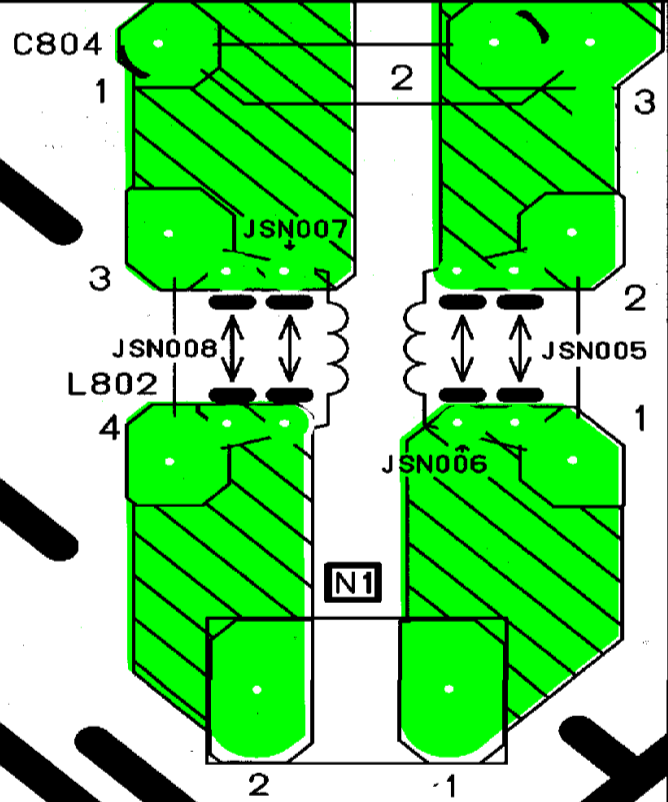
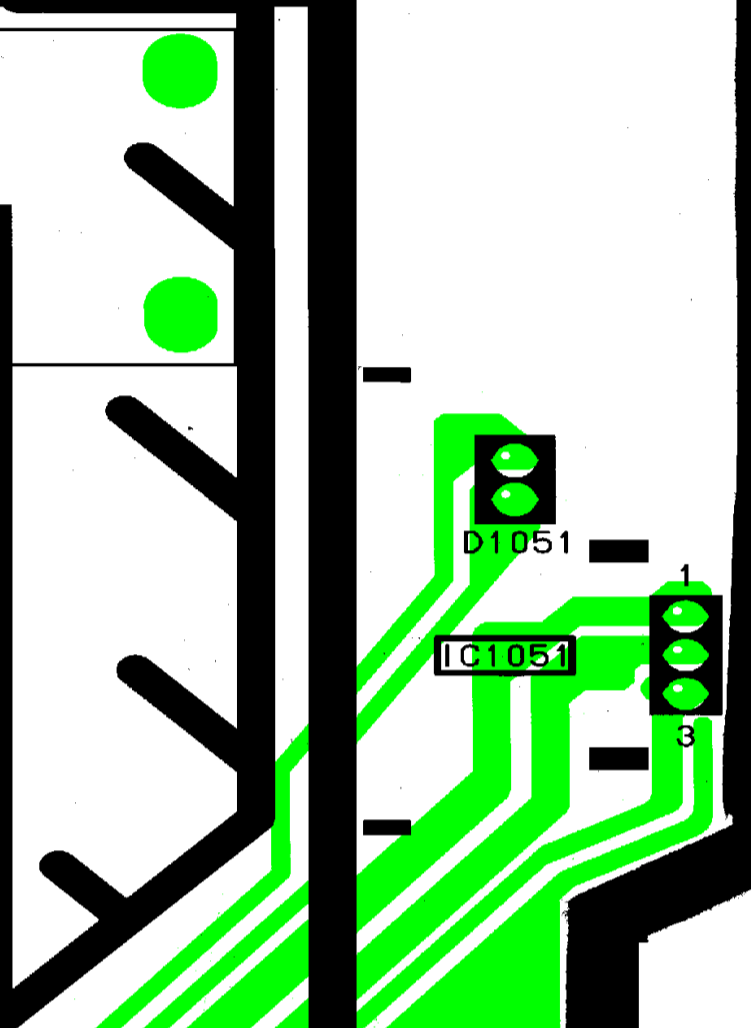
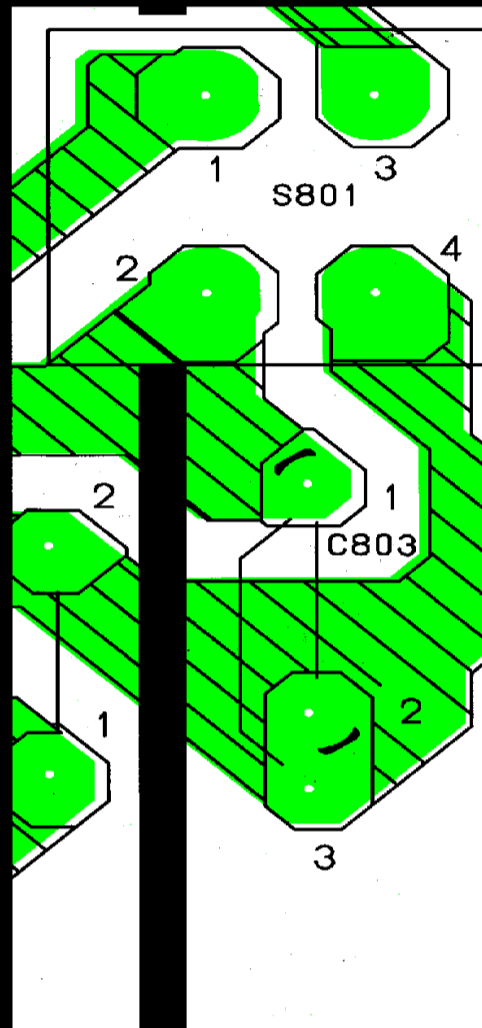
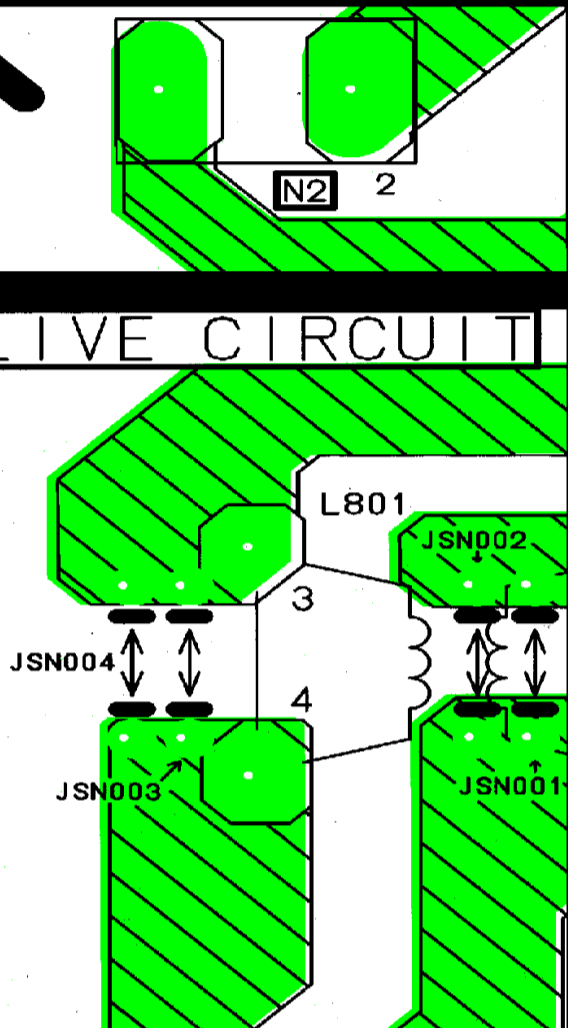

TNPA0763
SEE REVERSE FOR ORDER NO.

① (N)

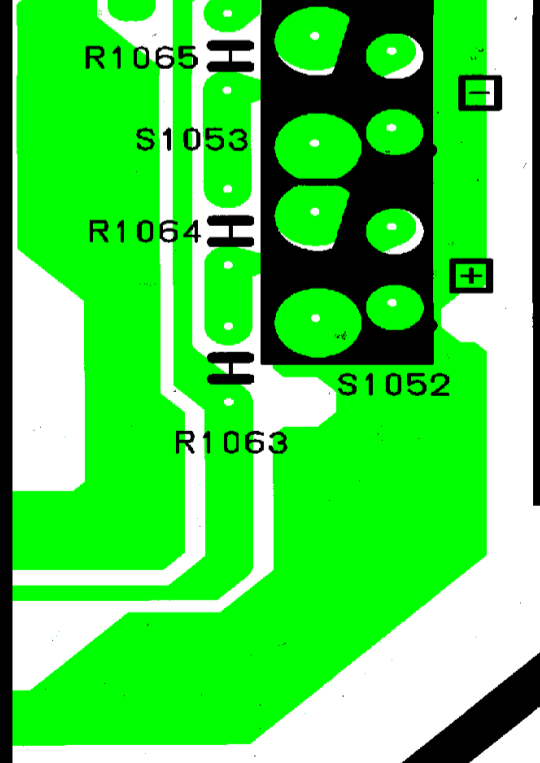
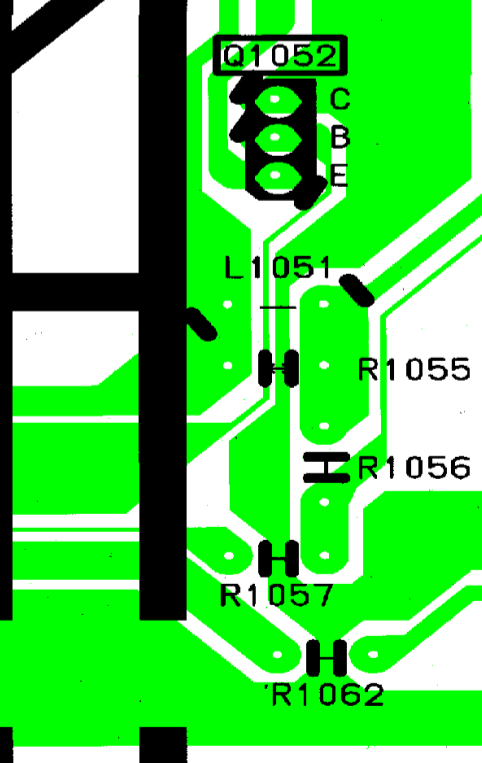
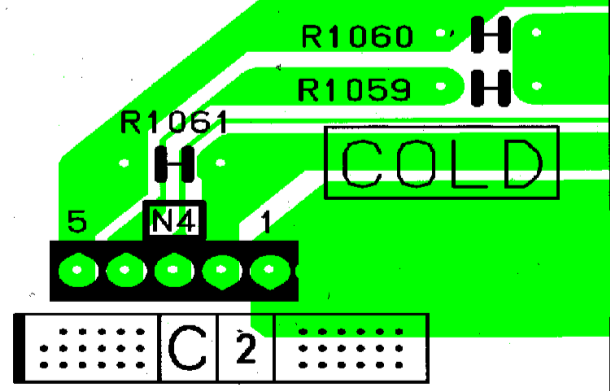

← DIP

TNP43764

(P) (1)

SEE REVERSE FOR ORDER NO.

..... C 2

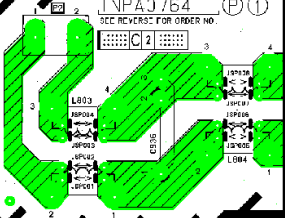

LIVE CIRCUIT

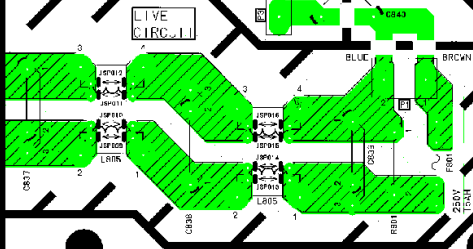

COLL

250V
T54H

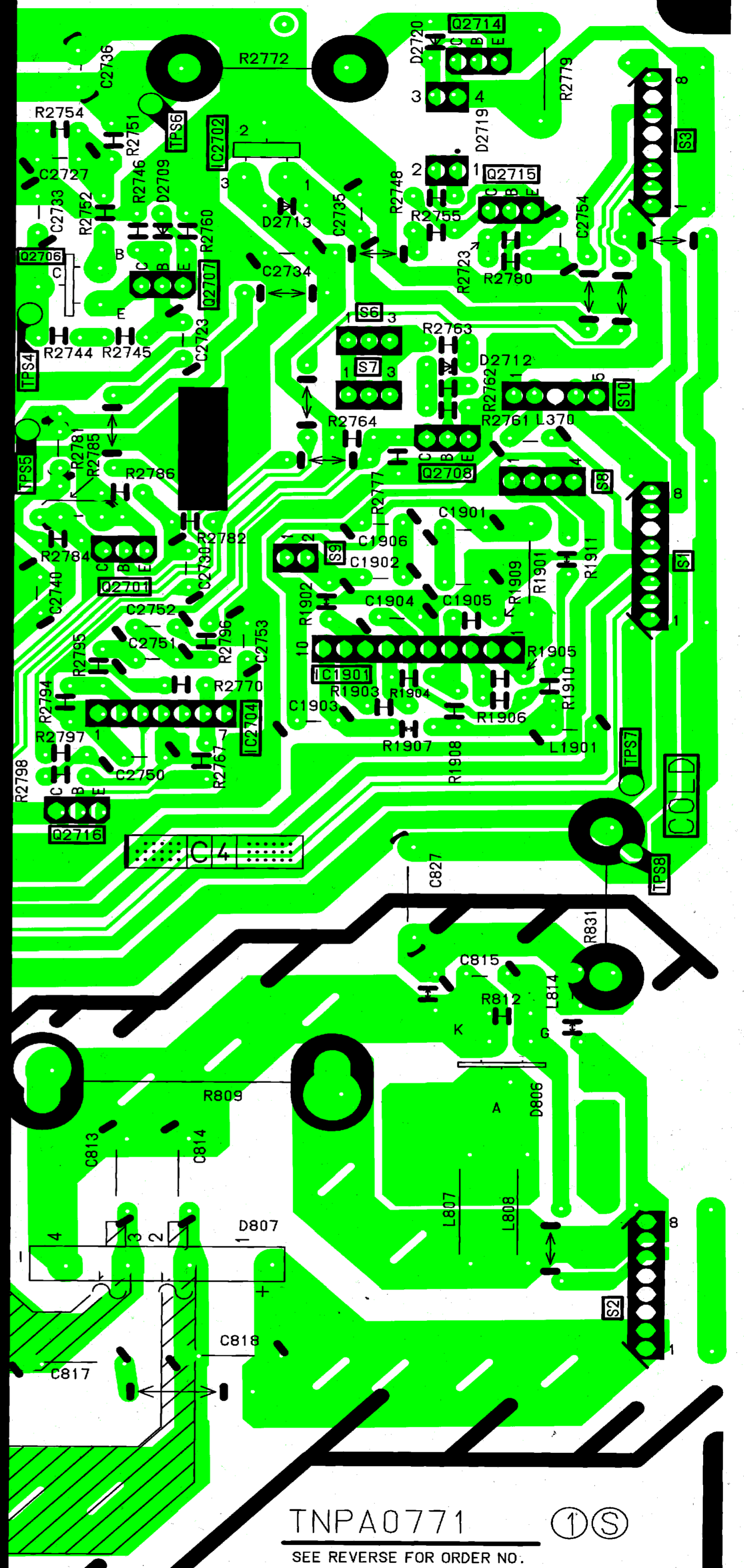
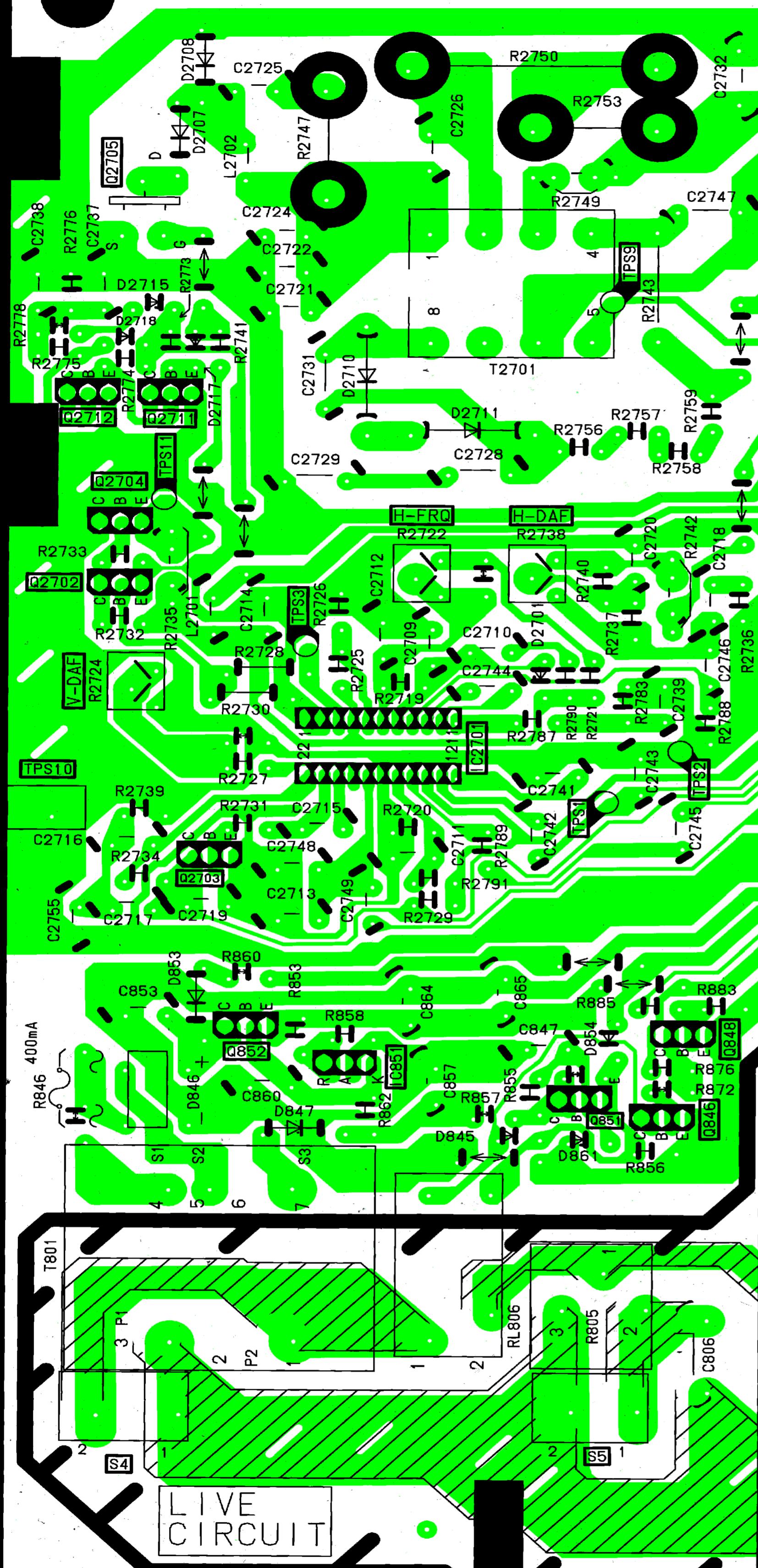

LIVE
CIRCUIT

TNPA0771 (1) (S)
SEE REVERSE FOR ORDER NO.

LIVE
CIRCUIT

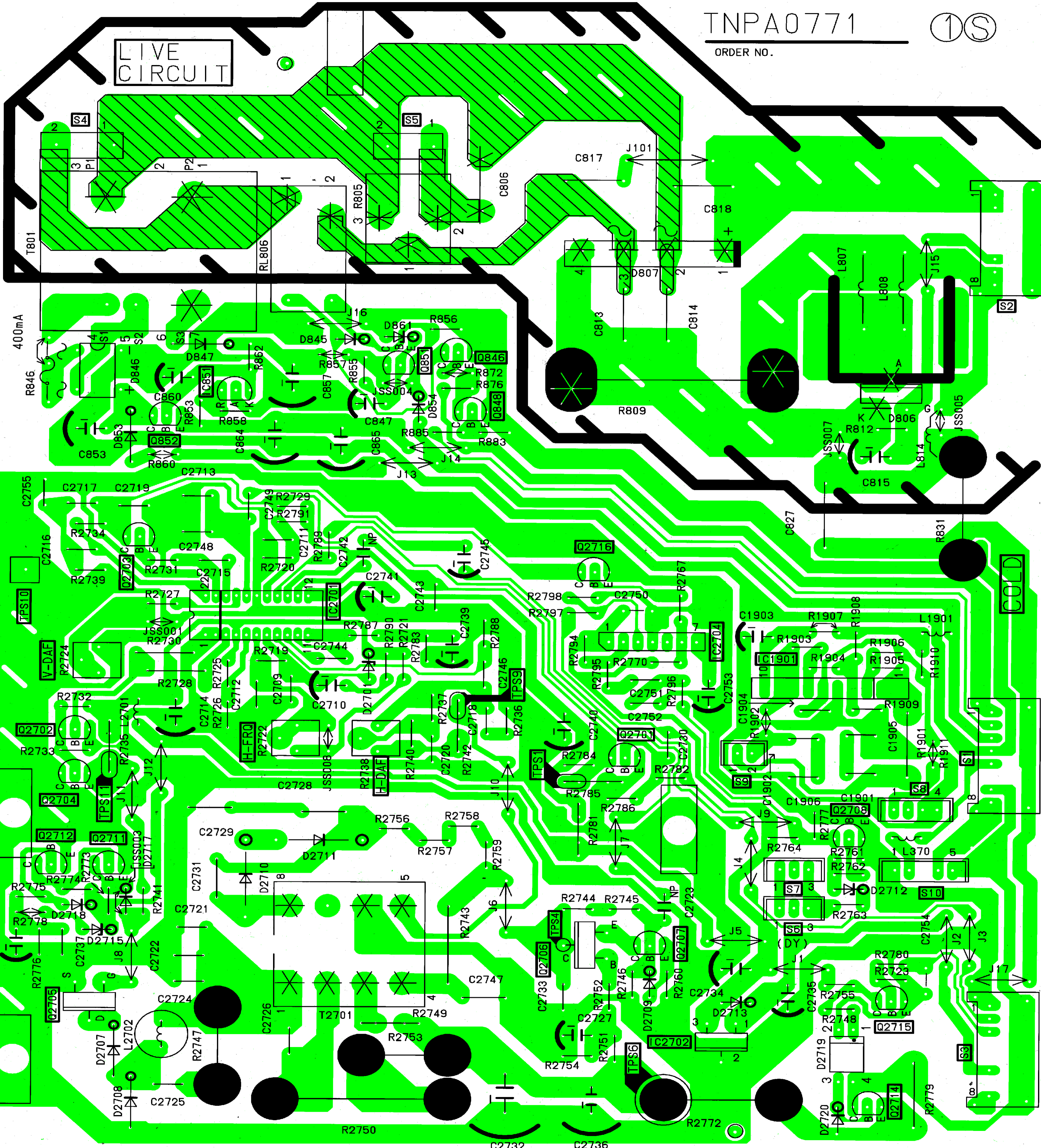

DIP ↑

TNPA0292

SEE REVERSE FOR ORDER NO.

(2) (Y)

H.V. DANGER

JK381

0908

0909

0905 0907

0906

0908

0908

0909

0908

0908

0908

0908

0908

0908

0908

